

900

ANTENAS TV BANDA UHF
TV ANTENNAS UHF BAND
ANTENNES TV BANDE UHF

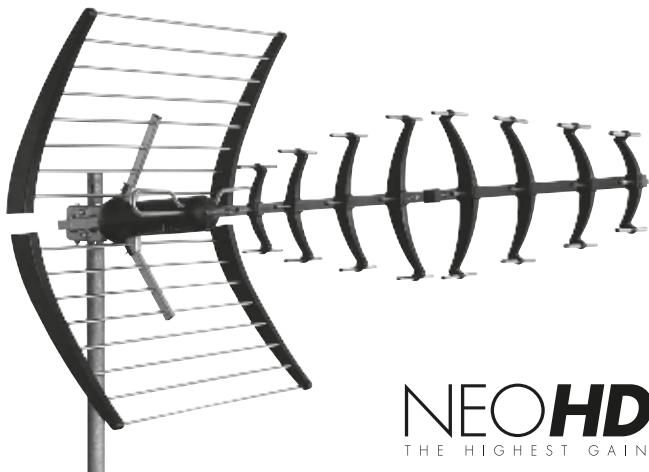

NEOHD
THE HIGHEST GAIN

CODIGO-CODE-CODE		9000201	9000187
MODELO-MODEL-MODELE		NEO-082	NEO-087
Rango de frecuencias Frequency range Gamme de fréquences	MHz	470 -694	
Canales Channels Canaux		21- 48	
Ganancia Gain Gain	dBi	18	
Rechazo LTE700 LTE700 rejection Rejet LTE700	dB	40	10
Relación delante/detrás Front/back ratio Rapport avant/arriere	dB	32	
Impedancia Impedance Impédance	Ω	75	
Pérdidas de retorno Return loss Pertes de retour	dB	≥ 10	
Polarización Polarity Polarisation		HOR /VER	
Ángulo de apertura Beam width Angle d'ouverture	$^{\circ}$ H	30	
	$^{\circ}$ V	28	
Longitud Lenght Longueur	mm	1160	
Resistencia al viento Wind loading Résistance au vent	N	H	125
		V	95
Índice de protección Protection index Indice de protection		IP 55	

Todas las antenas incorporan simetrizador.
All antennas supplied with matching transformer.
Toutes les antennes ont un symétriseur.

CÓMO MONTAR LA ANTENA

HOW TO MOUNT THE ANTENNA

COMMENT MONTER L'ANTENNE

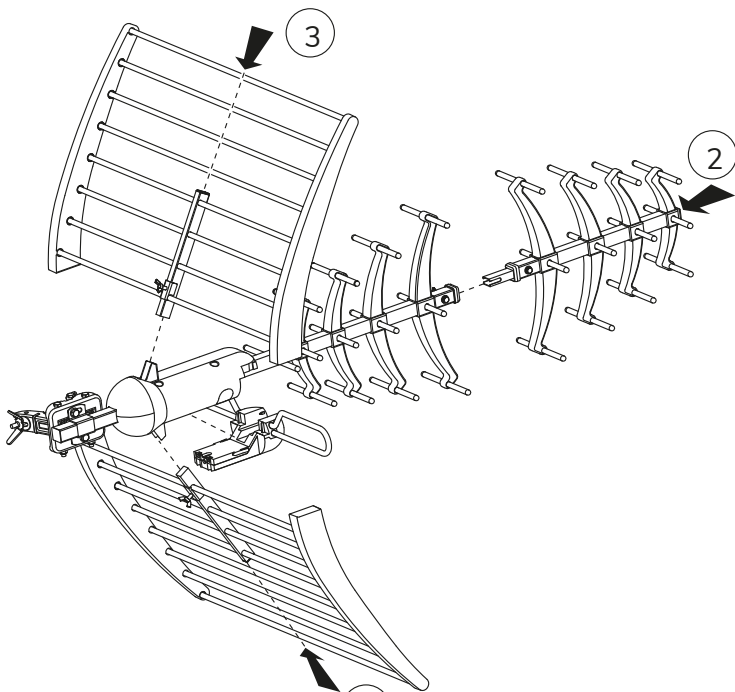

1

Cómo montar la caja del simetrizador
How to mount the matching transformer
Comment monter le boîtier du symétriseur

4

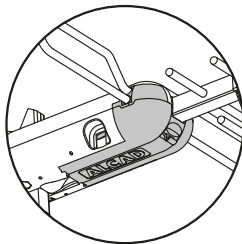
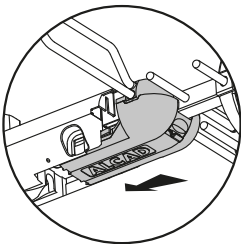
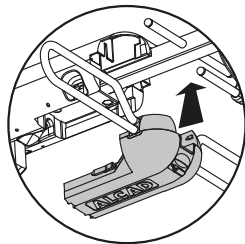

CÓMO FIJAR LA ANTENA AL MÁSTIL
HOW TO ATTACH THE ANTENNA TO THE MAST
COMMENT FIXER L'ANTENNE AU MÂT

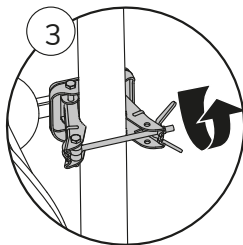
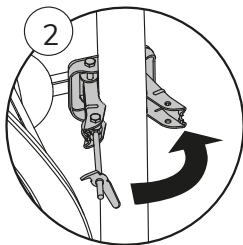
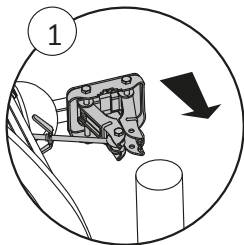
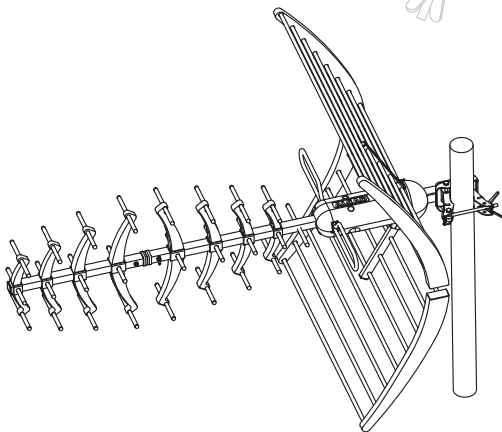
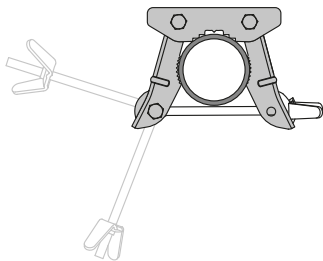
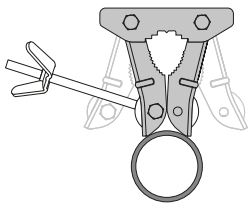

CÓMO CONECTAR EL CABLE COAXIAL EN LA CAJA DEL SIMETRIZADOR
HOW TO CONNECT THE COAXIAL CABLE TO THE MATCHING TRANSFORMER
COMMENT RELIER LE CÂBLE COAXIAL DANS LE BOÎTIER DU SYMÉTRISEUR

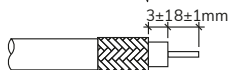
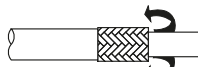
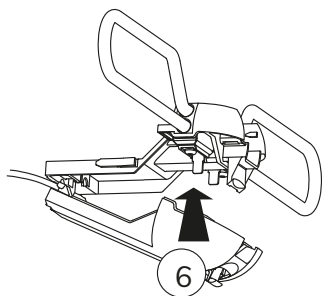
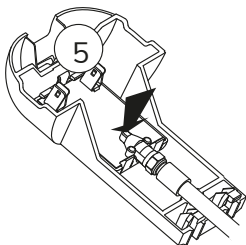
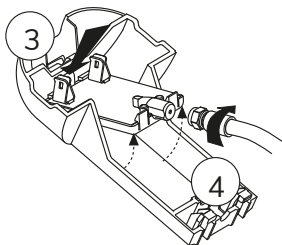
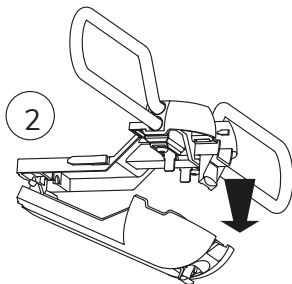
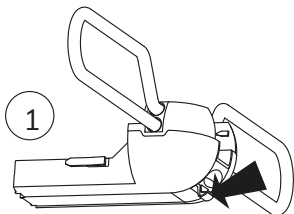

Ø 6,5 - 6,8 mm

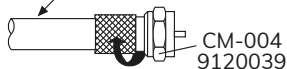

Ø 6,9 - 7,2 mm

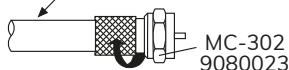

MONTAJE DE LA POLARIDAD HORIZONTAL O VERTICAL
MOUNTING IN EITHER HORIZONTAL OR VERTICAL POLARITY
MONTAGE EN HORIZONTAL OU VERTICAL

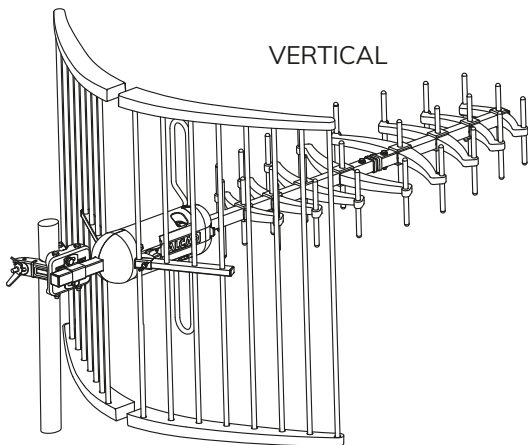
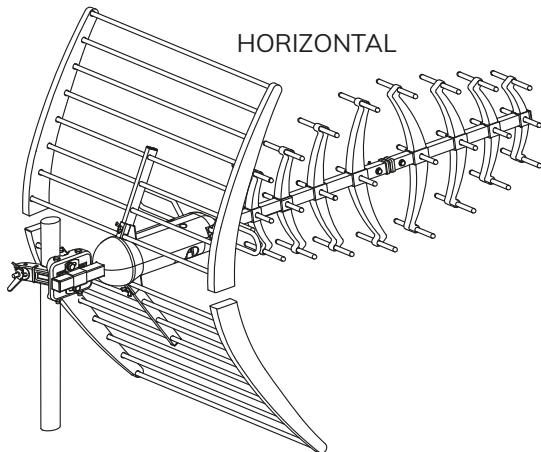

AJUSTE DEL ÁNGULO DE ELEVACIÓN ELEVATION ANGLE ADJUSTMENT RÉGLAGE DE L'ANGLE D'ÉLEVATION

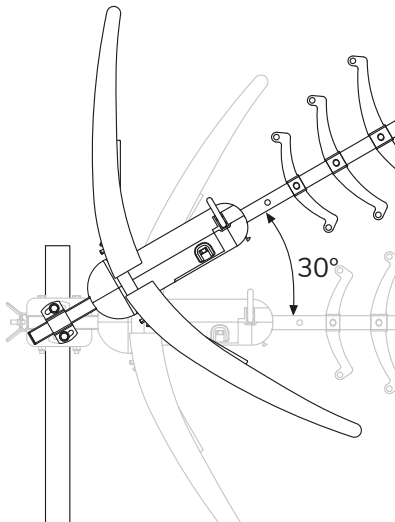

CURVA DE GANANCIA Y DIAGRAMAS DE RADIACIÓN GAIN AND RADIATION GRAPHICS COURBE DU GAIN ET DIAGRAMME DE RAYONNEMENT

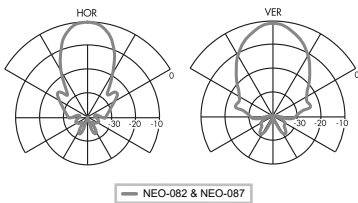
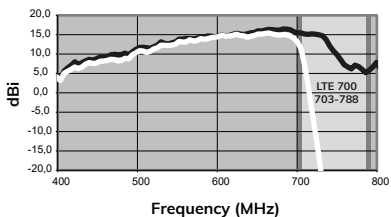

— NEO-087 — NEO-082