

Product Catalogue

Funke is official member of



DIGITAG
Digital Television Action Group



'Together Clearly the Best!' is our company motto because we strongly believe that success can only be achieved by working together with all elements that form your business. Clients, collaborators, colleagues and, funnily enough, even competitors all help us, in their own way, to improve all the aspects of our organisation and motivate us to make things better. Ultimately, this synergy is translated into a process aimed at creating a product whose quality will satisfy the expectations of our clients and fulfil the needs of the end users. Since 1957, many years before we even thought of our company motto, high quality, innovation, customer-oriented service and cooperation have been the core values of Funke Digital TV, and today we proudly give you a taste of these core values transformed into products. Let us present our accomplishments and show you what you – as an important part, even an element, of our business – have helped us create. Enjoy the journey into our, and now your, little big Funke world!

Stan Baaijens

CEO of Funke Digital TV

DISCLAIMER

No rights can be claimed from the information in this catalogue. Although all is done to make the information as complete and correct as possible, no rights can be derived from the information presented in this catalogue.



Index

4G LTE INERT Technology	6
Outdoor Antennas	8
Indoor Antennas	18
In- & Outdoor Antennas	26
Long Distance Antennas	30
Portable Solutions	32
Automotive Antennas	38
Accessories	46
Specifications	54



4G LTE INERT Technology

4G LTE

4G LTE

LTE (Long-Term Evolution), commonly known as 4G LTE, is the name given to the standard for wireless communication of high-speed data for mobile phones and data terminals. The main goal of LTE was to augment the capacity and speed of wireless data networks.

In order to enable this exchange of high-speed data, mobile companies acquired a portion of the frequency band once appointed to TV signal broadcasting (791 MHz - 862 MHz). Since TV signal broadcasting makes use of the frequency band up to 790 MHz, there is just 1 MHz space between TV signal broadcasting and the new 4G LTE network. It is the proximity of both networks what could cause for some TV channels to experience interferences produced by the LTE signals and as a result show a frozen pixilated picture on the TV screen.

Funke's 4G LTE INERT technology

In order to prevent LTE interferences to affect TV signals, Funke has come up with a whole new technology called the Funke 4G LTE INERT technology. Unlike in other antenna products, the INERT technology applied to the Funke antennas does not only work by filtering the LTE signals, it also tackles the problem at its roots by working at the very beginning of the signal reception stage.

The way this technology works is twofold. First it weakens TV signal reception around the 790 MHz and then it smart filters any residue of LTE signals, allowing only the TV signal to pass into the Set-Top-Box. The Funke 4G LTE INERT technology also avoids any thru loss to take place while filtering and it protects the antenna amplifier from the LTE signals. This all together offers the ultimate solution to a problem - that one of interferences produced by the 4G LTE network - that might occur frequently once the 4G LTE networks are fully deployed and used by more and more mobile users.



DSC310

The Funke DSC310 is a very compact digital outdoor TV antenna. With its small size and stylish look it is appropriate for every location. This complete easy to install solution is a trendy substitute for traditional rooftop antennas; it guarantees perfect performance. The innovative and high quality technology with which this antenna is equipped offers a continuous and sustainable digital TV reception. The Funke DSC310 is provided with Funke's 4G LTE INERT technology; the best way to protect your TV signal reception from 4G LTE interferences.

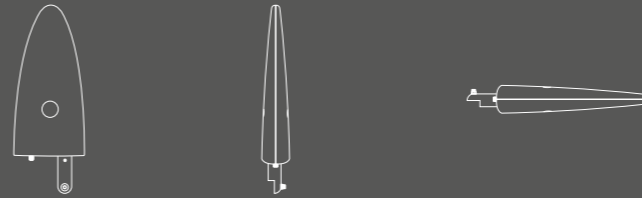

Outdoor Antennas



Outdoor



ODSC100

The Funke ODSC100 is specially developed for the best outdoor reception of DTT signals. This digital outdoor antenna guarantees the best performance regardless of geographical features, like mountains, or buildings. It is a compact and easy to install antenna. Whether it is used to watch digital television at home, while camping or while spending some leisure time on the water. The Funke ODSC10 is provided with Funke's 4G LTE INERT technology; the best way to protect your TV signal reception from 4G LTE interferences.

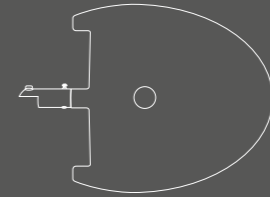

funke.

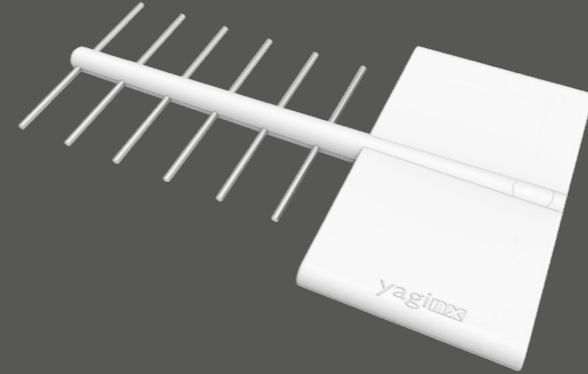

YagiNX

The Funke YagiNX brings the trusted and proven concept of the yagi antenna to the 21st century. This antenna does not only put the performance of larger antennas in a small package, it also protects you from the interferences caused by the 4G network. Because of its compact size and modern technology, installation is as easy as changing a light bulb. The Funke YagiNX is provided with Funke's 4G LTE INERT technology; the best way to protect your TV signal reception from 4G LTE interferences.

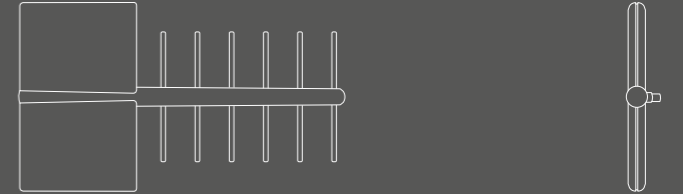



City 5.1

The Funke City 5.1 is one of the most compact outdoor antennas available on the market. Perfect for urban areas, this easy to install solution, provides the best reception possible, free of sound and picture interference. Consumer expectations get fulfilled because signal reception is clear and continuous. Its trendy, edgy but subtle design makes this antenna to go unnoticed, what is perfect for the most exigent and aesthetics minded consumers. Infinite fun and enjoyment in the city. The Funke City 5.1 is provided with Funke's 4G LTE INERT technology; the best way to protect your TV signal reception from 4G LTE interferences.

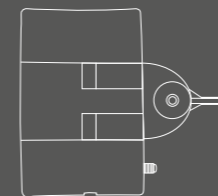
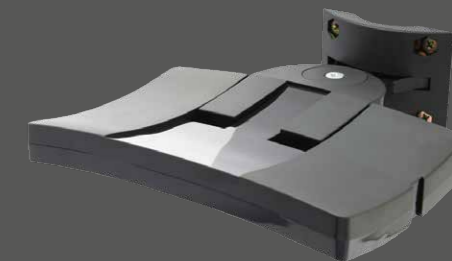

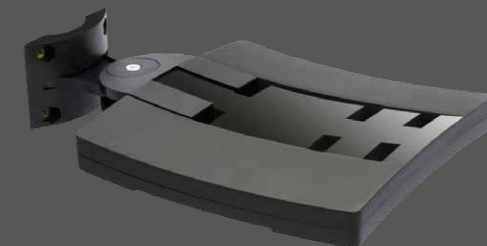
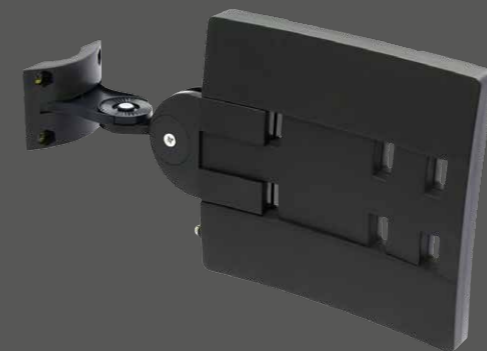

City 5.5

The Funke City 5.5 is an outdoor digital antenna of modern and trendy design but still tough and robust. This antenna solution performs flawlessly under all type of weather conditions. Easy to install at any outdoor location, its innovative technology allows the viewer to enjoy the latest technologies in digital television. The Funke City 5.5 is provided with Funke's 4G LTE INERT technology; the best way to protect your TV signal reception from 4G LTE interferences.

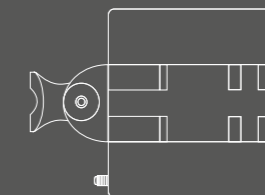



DSC250

The Funke DSC250 is a perfect combination of stylish design and state of the art technology. This digital indoor antenna offers you the best indoor reception of DTT signals. It is an easy plug & play solution to watch digital TV at home. With its compact size and sustainable performance, it has proven to be the best choice in indoor digital TV antennas. The Funke DSC250 is provided with Funke's 4G LTE INERT technology; the best way to protect your TV signal reception from 4G LTE interferences.



Indoor Antennas



Indoor



DSC550

The Funke DSC550 4G LTE Indoor antenna provides you with a unique technical solution that guarantees a 4G LTE free TV signal reception that is proven to be the best one in the market. Its popular and thinnest design makes the DSC550 4G LTE blend perfectly into any interior. The Funke DSC550 is the first indoor antenna to be provided with Funke's 4G LTE INERT technology; the best way to protect your TV signal reception from 4G LTE interferences.

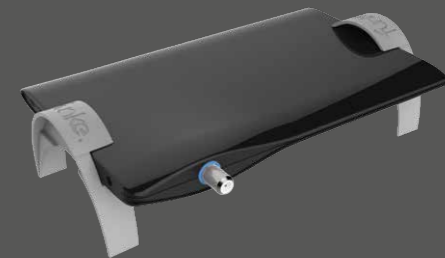



Home 2.0

The Funke Home 2.0, small-sized and trendy, has proven to be among one of the best performing digital indoor antennas on the market. With a design that matches all type of interiors, it provides hours of fun watching digital television. Thanks to its innovative technology TV signal reception is consistent and continuous. The Funke Home 2.0 is provided with Funke's 4G LTE INERT technology; the best way to protect your TV signal reception from 4G LTE interferences.

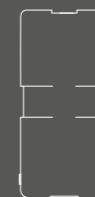
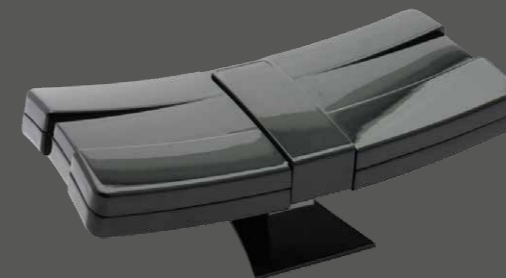



Home 5.0

The Funke Home 5.0 is one of the strongest, yet sophisticated, indoor antennas on the market. Its unique technology allows users of this antenna to enjoy watching digital TV. Next to this, its design of delicate lines fits perfectly with other audio-visual devices in the house. The combination resulting from high quality performance and stylish design makes of this antenna the ideal solution for indoor digital signal reception. The Funke Home 5.0 is provided with Funke's 4G LTE INERT technology; the best way to protect your TV signal reception from 4G LTE interferences.

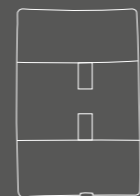
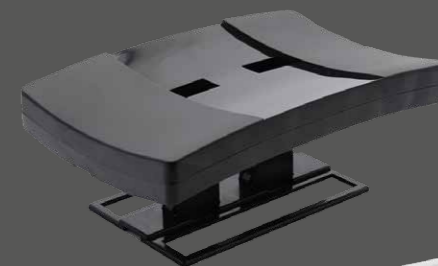



In- & Outdoor Antennas

DSC510E

The Funke DSC510E indoor and outdoor digital antenna is a pioneering signal reception solution provided with the latest state-of-the-art technology. When performing best outdoor, the easy installation system of this antenna allows its user to have it installed outside but without having to go onto the rooftop. Its revolutionary technique guarantees the best possible reception of DTT signal. The Funke DSC510E is extendable for better and continuous reception, regardless of its environment. The Funke DSC510E is provided with Funke's 4G LTE INERT technology; the best way to protect your TV signal reception from 4G LTE interferences.

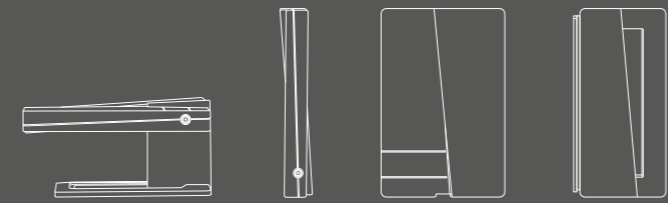



Combo 5.1

The Funke Combo 5.1 indoor and outdoor digital antenna offers you the best of both worlds. This highly performing TV antenna enables you to experience watching TV whenever you want. This combo antenna solution comes with a distinctive range of handy accessories, which can also be used indoors. The Funke Combo 5.1 is provided with Funke's 4G LTE INERT technology; the best way to protect your TV signal reception from 4G LTE interferences.

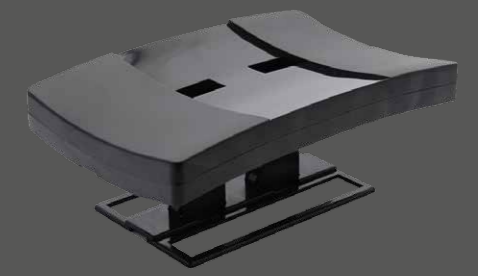



Long Distance Antennas

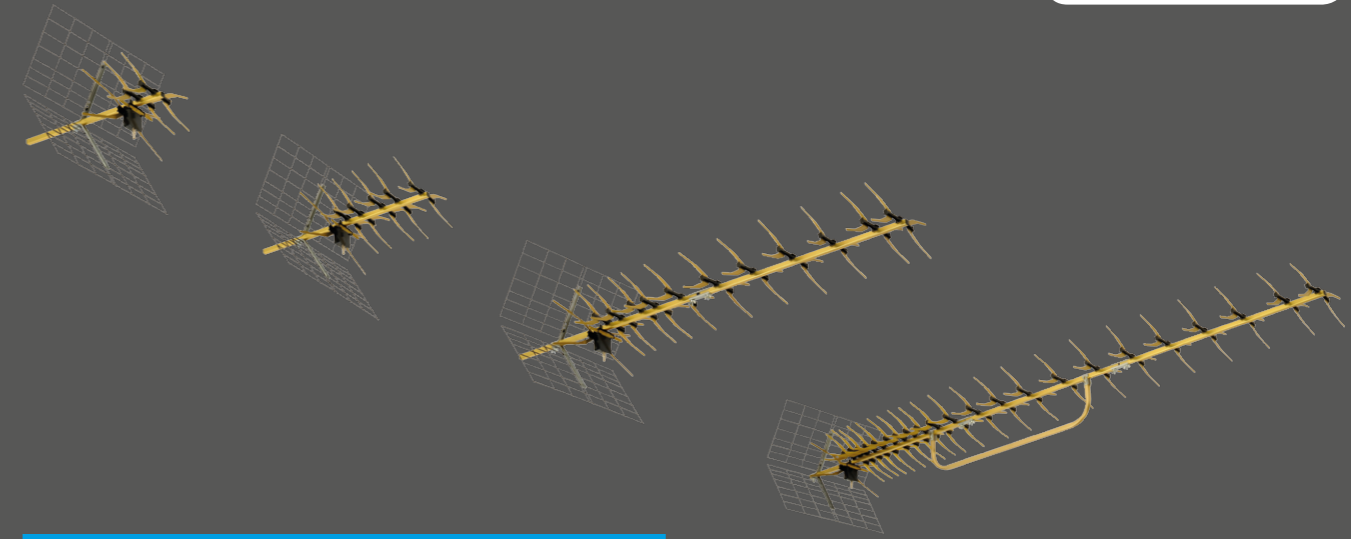

(A)BM-Series

The Funke long-distance active ABM and passive BM antenna series have been specially developed for the outdoor reception of DTT signals. The selected range of long-distance outdoor antennas guarantees the best performance, regardless of geographical features like mountains or buildings. This antenna is suitable for any location and in all weather conditions.



Portable Solutions

Portable

TV4ME



Without any wiring or subscription, TV4ME creates a second TV anywhere, so you can watch TV everywhere at home or on the go! TV4ME offers 4 hours of entertainment on a single charge, is easy to install, has an intuitive interface and supplies you with up to 7 days EPG. Whenever needed, TV4ME can also charge your phone's battery.

You are no longer restricted by TV programming because in a few clicks on the EPG you can schedule TV4ME to record your favourite program so you can watch it back whenever you want. Many hours of video can be recorded on Micro SD card and played later on any of your smart devices.



Apple
iPhone 4S or newer
Any iPad
iOS4.3 or later

Android
1 GHz minimum CPU
Android 2.3 or newer

PC / MAC
1 GHz minimum CPU
Windows XP or newer
OSX 10.7 or newer
Supports SD & HD!



StiQ 1.0

The Funke StiQ is a fun device which allows you to watch digital TV on your laptop within an urban setting. The StiQ gives you the freedom to watch & record TV whenever you want! The StiQ's take-me-everywhere design can be taken along on any trip.

Features: PVR, EPG, Timeshift, etc.



Windows
Windows® XP (32 Bit) or later
Intel® Pentium® 4 2,0 GHz, Pentium® M 1,3 GHz or equivalent AMD®Athlon™ XP
Sound/graphics controllers with support for DirectX® 9 or higher

Mac OS
Macintosh® computer with a PowerPC® G4, G5 or Intel Core® processor





Portable

PCTV250

The Funke PCTV250 is a perfect combination of stylish design and state-of-the-art technology. This portable and active digital antenna, with tuner integrated, offers you the best possible reception of DTT signal. This portable antenna is available for both DVB-T and ISDB-T standards. It is an ideal all-in-one solution to watch digital TV on your notebook, laptop and PC. Thanks to its continuous performance, the Funke PCTV250 has proven to be the best signal reception solution in portable digital TV. Enjoy watching digital TV anywhere, anytime!

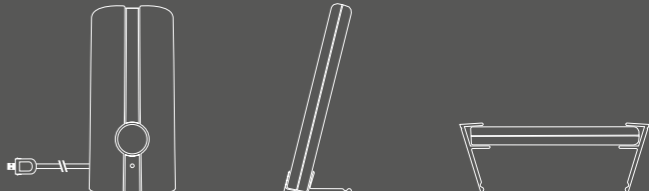



Automotive Antennas

Automotive

DAB DAB+
DIGITALRADIO

ADSC700

The Funke ADSC700 Car Antenna for DAB and DAB+ is one of the best performing products available on the market and ensures crystal clear reception! With this antenna you can receive all available channels on air. Its transparent design is easy to install. Let's get digital: more channels & better reception.

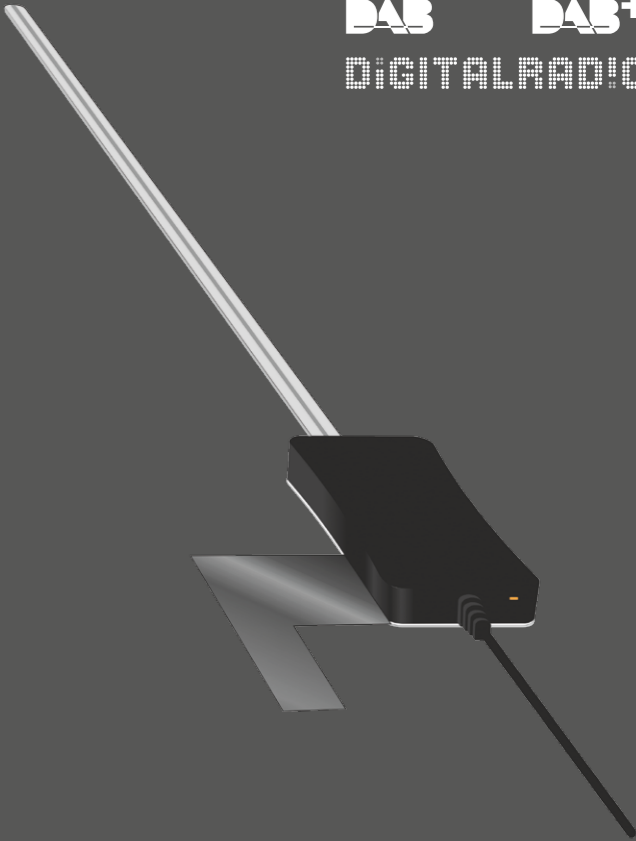
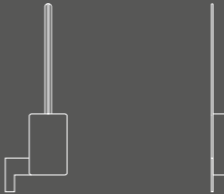

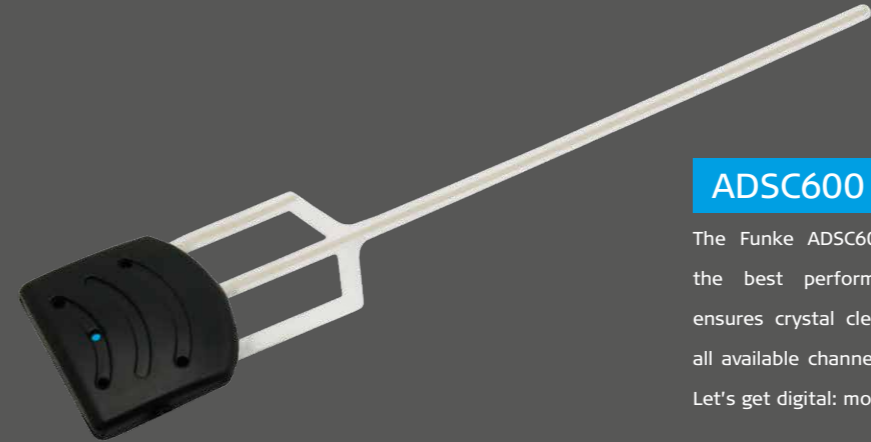

ADSC600

The Funke ADSC600 Car Antenna for DAB and DAB+ is one of the best performing products available on the market and ensures crystal clear reception! With this antenna you can receive all available channels on air. Its transparent design is easy to install. Let's get digital: more channels & better reception.

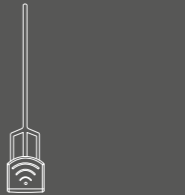



ADSC410

The innovative technique of the Funke ADSC410 automotive antenna allows its user to watch digital TV while on the move. This digital antenna is specially developed for the automotive branch and offers a high quality TV digital signal reception for every occasion. The high quality Funke ADSC410 antenna has a compact size, solid design and it is Ultra HDTV and 3DTV compatible.

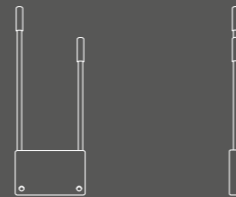



ADSC470

With the Funke ADSC470 automotive antenna you can receive digital TV signals in your vehicle. The Funke ADSC470 comes in a set of two antennas and it has been specially developed for after-market installation. By making use of two antennas the ADSC470 guarantees its user to obtain the highest possible signal reception. The Funke ADSC470 has an easy to install unique design and it is also Ultra HDTV and 3DTV compatible. The Funke ADSC470 is provided with Funke's 4G LTE INERT technology; the best way to protect your TV signal reception from 4G LTE interferences.

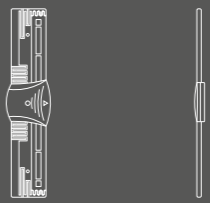
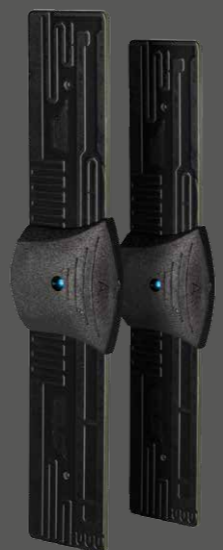



Accessories

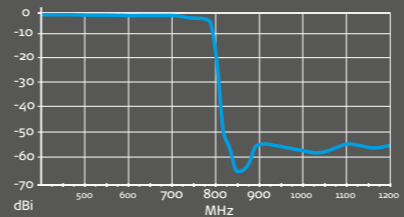

NLTE790

The Funke NLTE790 is a smart solution for watching digital TV without signal reception being interrupted by 4G LTE signal emission. Thanks to the applied state-of-the-art technology and the sustainable performance of this product, it has proven to be the best choice in 4G LTE interference avoidant in-line filters. The Funke NLTE790 is provided with Funke's 4G LTE INERT technology; the best way to protect your TV signal reception from 4G LTE interferences.

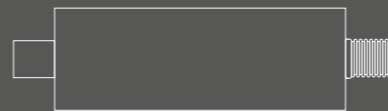



PI150

The Funke PI150 USB Power Inserter is specially developed to connect any active antenna directly to a TV (with integrated DTT tuner) or Set-Top-Box without antenna power outlet. It will enable the antenna to perform at its maximum capacity with minimal cabling and components.

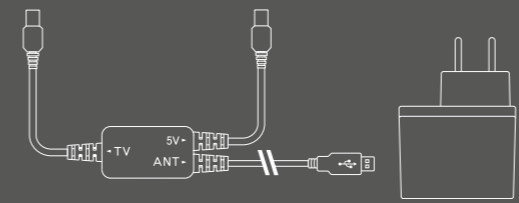



Universal PI

The Funke Universal Power Inserter is a great value for money antenna accessory that helps to activate the antenna in those cases when neither the TV set nor the Set-Top-Box provide the antenna with the necessary 5 Volts that allow it to properly function. The Funke Universal Power Inserter is fitted with a F-connector but also includes IEC-adaptors for universal usage. A single solution that fits all!

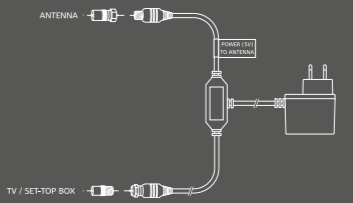

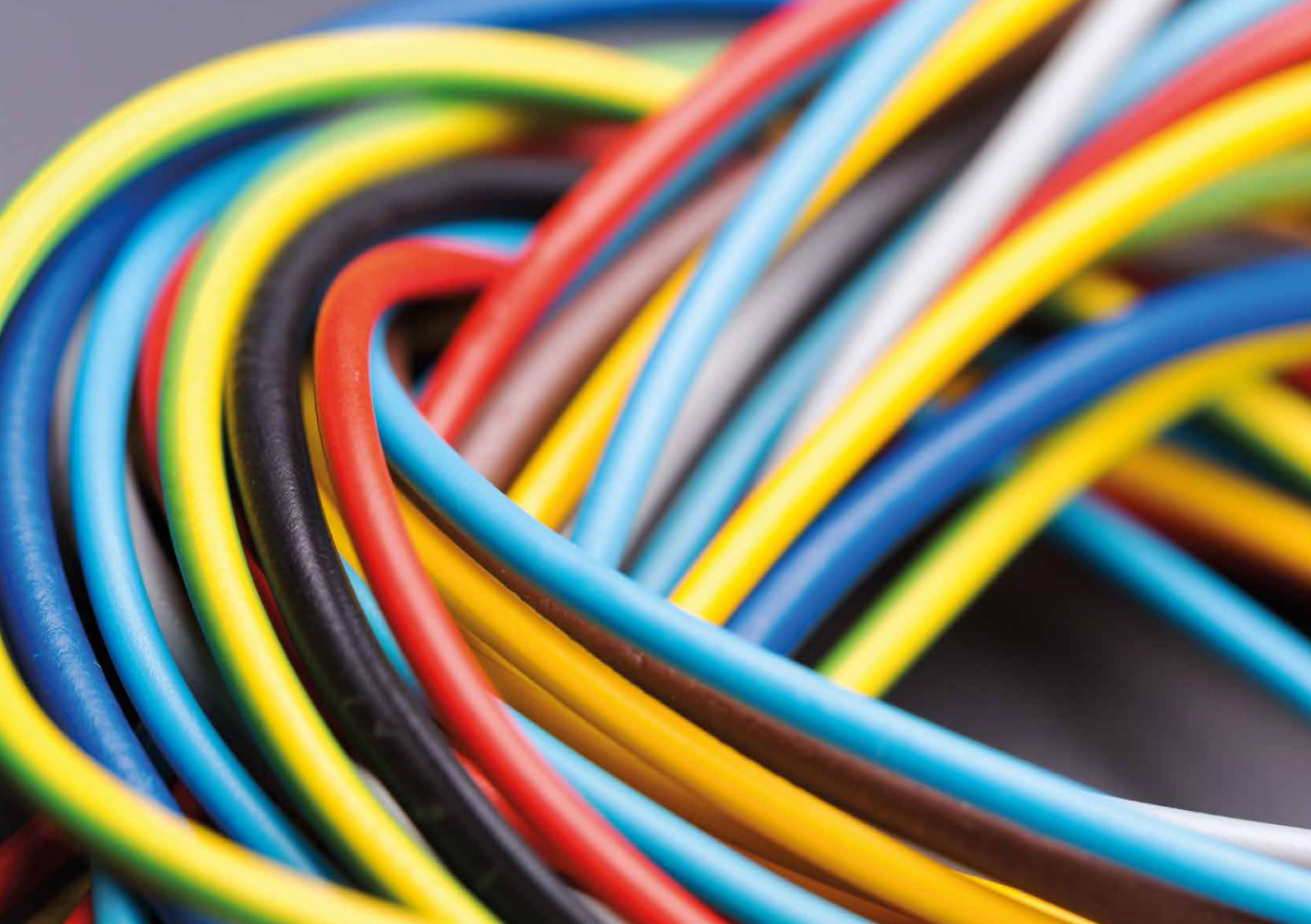

Coaxial Cables

When installing a high quality antenna, it is equally important to use a high quality coaxial cable to maintain the received signal and minimize the addition of noise. Funke offers a range of coaxial cables for indoor and for outdoor use in different lengths and with different connectors which all have premium shielding.

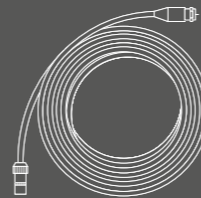



Specifications

	DSC310 H40 470-790	ODSC100 H40 470-790	YagiNX H40 470-790	City 5.1 L40 470-790
Preferred applications	Outdoor stationary reception	Outdoor stationary reception	Outdoor stationary reception	Outdoor stationary reception
Indicative reception distance	35 km	40 km	60 km	40 km
Channels VHF				
Channels UHF	21 - 60 (470 - 790 MHz)	21 - 60 (470 - 790 MHz)	21 - 60 (470 - 790 MHz)	21 - 60 (470 - 790 MHz)
Total gain VHF				
Total gain UHF	20 dBi	26 dBi	27 dBi	18 dBi
Input voltage	5 ± 0,5 VDC	5 ± 0,5 VDC	5 ± 0,5 VDC	5 ± 0,5 VDC
Input current	40 mA typ.	40 mA typ.	40 mA typ.	40 mA typ.
Amplifier principle	Low noise amplifier	Low noise amplifier	Ultra low noise amplifier	Low noise amplifier
Connection	F-female	F-female	F-female	F-female
Cable				
Colour	Grey	White	Off-white	Black
Dimensions (h x w x d)	240 x 110 x 42 mm	237 x 223 x 22 mm	380 x 225 x 40 mm	192 x 122 x 37 mm
Weight	190 gr	290 gr	400 gr	137 gr

	City 5.5 H40 470-790	DSC250 L40 470-790	DSC550 L40 470-790	Home 2.0 L40 470-790
Preferred applications	Outdoor stationary reception	Indoor stationary reception	Indoor stationary reception	Indoor stationary reception
Indicative reception distance	50 km	30 km	45 km	25 km
Channels VHF				
Channels UHF	21 - 60 (470 - 790 MHz)	21 - 60 (470 - 790 MHz)	21 - 60 (470 - 790 MHz)	21 - 60 (470 - 790 MHz)
Total gain VHF				
Total gain UHF	20 dBi	15 dBi	15 dBi	15 dBi
Input voltage	5 ± 0,5 VDC	5 ± 0,5 VDC	5 ± 0,5 VDC	5 ± 0,5 VDC
Input current	40 mA typ.	40 mA typ.	40 mA typ.	40 mA typ.
Amplifier principle	Low noise amplifier	Low noise amplifier	Ultra low noise amplifier	Low noise amplifier
Connection	F-female	IEC-male	F-female	IEC-male
Cable		3,5 m flexible coaxial cable		3,5 m flexible coaxial cable
Colour	White	Black	Black /White	Black
Dimensions (h x w x d)	192 x 182 x 36 mm	158 x 72 x 17 mm	192 x 125 x 18 mm	155 x 75 x 26 mm
Weight	280 gr	140 gr	144 gr	135 gr

	Home 5.0 L40 470-790	DSC510E H40 470-790	Combo 5.1 L40 470-790
Preferred applications	Indoor stationary reception	Indoor & Outdoor stationary reception	Indoor & Outdoor stationary reception
Indicative reception distance	40 km	50 km	40 km
Channels VHF			
Channels UHF	21 - 60 (470 - 790 MHz)	21 - 60 (470 - 790 MHz)	21 - 60 (470 - 790 MHz)
Total gain VHF			
Total gain UHF	18 dBi	27 dBi	18 dBi
Input voltage	5 ± 0,5 VDC	5 ± 0,5 VDC	5 ± 0,5 VDC
Input current	40 mA typ.	40 mA typ.	40 mA typ.
Amplifier principle	Low noise amplifier	Low noise amplifier	Low noise amplifier
Connection	F-female	F-female	F-female
Cable			
Colour	Black	Black	Black
Dimensions (h x w x d)	192 x 122 x 37 mm	192 x 125 x 27 mm	192 x 122 x 37 mm
Weight	137 gr	250 gr	137 gr

	ABM4515 H40 470-862	ABM4527 H40 470-862	ABM4551 H40 470-862	ABM4595 H40 470-862
Preferred applications	Outdoor stationary reception	Outdoor stationary reception	Outdoor stationary reception	Outdoor stationary reception
Elements	15	27	51	95
Indicative reception distance	45 km	55 km	65 km	75 km
Windload (@ 120 km/h)	30 N	60 N	98 N	164 N
Working temperature	-40°C / +50°C	-40°C / +50°C	-40°C / +50°C	-40°C / +50°C
Channels VHF				
Channels UHF	21 - 69 (470 - 862 MHz)	21 - 69 (470 - 862 MHz)	21 - 69 (470 - 862 MHz)	21 - 69 (470 - 862 MHz)
Antenna gain VHF				
Antenna gain UHF	7 dBi	9 dBi	11 dBi	13 dBi
Amplifier gain VHF & UHF	23 dBi	23 dBi	23 dBi	23 dBi
Total gain VHF				
Total gain UHF	30 dBi	32 dBi	34 dBi	36 dBi
Horizontal beamwidth	49 - 36°	48 - 30°	42 - 24°	34 - 20°
Vertical beamwidth	60 - 43°	58 - 40°	48 - 28°	34 - 22°
Directivity (front/back)	25 dB	25 dB	26 dB	28 dB
Input voltage	5 ± 0,5 VDC	5 ± 0,5 VDC	5 ± 0,5 VDC	5 ± 0,5 VDC
Input current	40 mA typ.	40 mA typ.	40 mA typ.	40 mA typ.
Output impedance	75 Ω	75 Ω	75 Ω	75 Ω
Amplifier principle	Low noise amplifier	Low noise amplifier	Low noise amplifier	Low noise amplifier
Connection	F-female	F-female	F-female	F-female
Material	Gold anodized aluminium	Gold anodized aluminium	Gold anodized aluminium	Gold anodized aluminium
Working temperature	-40°C / +50°C	-40°C / +50°C	-40°C / +50°C	-40°C / +50°C
Length	460 mm	685 mm	1350 mm	2230 mm
Weight	0,800 kg	1,000 kg	1,350 kg	2,250 kg

	BM3517 P 174-862	BM3529 P 174-862	BM3553 P 174-862	BM3597 P 174-862
Preferred applications	Outdoor stationary reception	Outdoor stationary reception	Outdoor stationary reception	Outdoor stationary reception
Elements	17	29	53	97
Indicative reception distance	25 km	35 km	45 km	55 km
Windload (@ 120 km/h)	47 N	77 N	115 N	181 N
Working temperature	-40°C / +50°C	-40°C / +50°C	-40°C / +50°C	-40°C / +50°C
Channels VHF	5 - 12 (174 - 230 MHz)	5 - 12 (174 - 230 MHz)	5 - 12 (174 - 230 MHz)	5 - 12 (174 - 230 MHz)
Channels UHF	21 - 69 (470 - 862 MHz)	21 - 69 (470 - 862 MHz)	21 - 69 (470 - 862 MHz)	21 - 69 (470 - 862 MHz)
Antenna gain VHF	3 dBi	3 dBi	3 dBi	3 dBi
Antenna gain UHF	7 dBi	8 dBi	10 dBi	12 dBi
Amplifier gain VHF & UHF				
Total gain VHF	3 dBi	3 dBi	3 dBi	3 dBi
Total gain UHF	7 dBi	8 dBi	10 dBi	12 dBi
Horizontal beamwidth	49 - 36°	48 - 30°	42 - 24°	34 - 20°
Vertical beamwidth	60 - 43°	58 - 40°	48 - 28°	34 - 22°
Directivity (front/back)				
Input voltage				
Input current				
Output impedance	75 Ω	75 Ω	75 Ω	75 Ω
Amplifier principle				
Connection	F-female	F-female	F-female	F-female
Material	Gold anodized aluminium	Gold anodized aluminium	Gold anodized aluminium	Gold anodized aluminium
Working temperature	-40°C / +50°C	-40°C / +50°C	-40°C / +50°C	-40°C / +50°C
Length	470 mm	680 mm	1380 mm	2280 mm
Weight	0,910 kg	0,985 kg	1,235 kg	1,775 kg

	BM4515 P 470-862	BM4527 P 470-862	BM4551 P 470-862	BM4595 P 470-862
Preferred applications	Outdoor stationary reception	Outdoor stationary reception	Outdoor stationary reception	Outdoor stationary reception
Elements	15	27	51	95
Indicative reception distance	25 km	35 km	45 km	55 km
Windload (@ 120 km/h)	30 N	60 N	98 N	164 N
Working temperature	-40°C / +50°C	-40°C / +50°C	-40°C / +50°C	-40°C / +50°C
Channels VHF				
Channels UHF	21 - 69 (470 - 862 MHz)	21 - 69 (470 - 862 MHz)	21 - 69 (470 - 862 MHz)	21 - 69 (470 - 862 MHz)
Antenna gain VHF				
Antenna gain UHF	7 dBi	9 dBi	11 dBi	13 dBi
Amplifier gain VHF & UHF				
Total gain VHF				
Total gain UHF	7 dBi	9 dBi	11 dBi	13 dBi
Horizontal beamwidth	49 - 36°	48 - 30°	42 - 24°	34 - 20°
Vertical beamwidth	60 - 43°	58 - 40°	48 - 28°	34 - 22°
Directivity (front/back)				
Input voltage				
Input current				
Output impedance	75 Ω	75 Ω	75 Ω	75 Ω
Amplifier principle				
Connection	F-female	F-female	F-female	F-female
Material	Gold anodized aluminium	Gold anodized aluminium	Gold anodized aluminium	Gold anodized aluminium
Working temperature	-40°C / +50°C	-40°C / +50°C	-40°C / +50°C	-40°C / +50°C
Length	460 mm	685 mm	1350 mm	2230 mm
Weight	0,800 kg	1,000 kg	1,350 kg	2,250 kg

	TV4ME	StiQ 1.0	PCTV250
Preferred applications	Portable reception in urban and remote areas	Portable reception in urban environment	Portable reception in urban environment
Indicative reception distance	30 km	10 km	
Available colours	Black & Blue	Black & Green	Black
Dimensions	98 x 62 x 12 mm	67 x 20 x 17 mm	158 x 72 x 17 mm
Weight	50 gr	33 gr	140 gr
Connection	i / micro USB	USB A 2.0	USB A 2.0
Supported TV standard	DVB-T	DVB-T	DVB-T / DVB-T2
Video format	MPEG-2, MPEG-4 H.264 / AVC	MPEG-2, MPEG-4 H.264 / AVC	MPEG-2, MPEG-4 H.264 / AVC
Audio format	MPEG audio layer 1/2 stereo/dual	MPEG audio layer 1/2 stereo/dual	MPEG audio layer 1/2 stereo/dual
Features	PVR / Scheduled recording / EPG / Time shifting	PVR / EPG / Time shifting	PVR / EPG / Time shifting

	ADSC700 H40 174-240	ADSC600 L38 174-1492	ADSC410 H30 174-790	ADSC470 H30 174-862
Preferred applications	Automotive DAB / DAB+ receiver	Automotive DAB / DAB+ receiver	Portable or mobile diversity receiver	Portable or mobile diversity receiver
Indicative reception distance	20 km	20 km	20 km	20 km
Channels VHF	5 - 13 (174 - 230 MHz)	5 - 12 (174 - 230 MHz)	5 - 12 (174 - 230 MHz)	5 - 12 (174 - 230 MHz)
Channels UHF		L-band (1452 - 1492 MHz)	21 - 60 (470 - 790 MHz)	21 - 69 (470 - 862 MHz)
Total gain VHF	17 dBi	11 - 18 dBi	4 - 6 dBi	4 - 6 dBi
Total gain UHF		5 - 11 dBi	16 dBi	16 dBi
Input voltage	5 - 28 VDC	5 - 12 VDC	5 ± 0,5 VDC	5 ± 0,5 VDC
Input current	40 mA. typ	38 mA typ.	30 mA typ.	30 mA typ.
Amplifier principle	Low noise amplifier	Low noise amplifier	Low noise amplifier	Low noise amplifier
Connection	Female angled SMB	Female angled SMB	F-male	F-male
Cable	3 m flexible coaxial cable	3 m flexible coaxial cable	5 m flexible coaxial cable	5 m flexible coaxial cable
Colour	Black / Transparent	Black / Transparent	Black	Black
Dimensions (h x w x d)	270 x 27x 8 mm	250 x 50 x 10 mm	178 x 65 x 9 mm	144 x 33 x 6,5 mm
Weight	50 gr	60 gr	130 gr	75 gr

	NLTE790	PI150	Universal PI
Preferred applications	Indoor active and passive terrestrial antennas	Remote power to active antenna	Remote power to active antenna
Power connection		AC power plug with USB out	AC power plug
RF connections	Female and male F-connector	PAL (IEC)	F male to F female (incl. adapters)
Input voltage		100 - 240 VAC - 50/60 Hz	101 - 240 VAC - 50/60 Hz
Output voltage		5 VDC	6 VDC
Output current		170 mA	171 mA
Loss		1 dB max.	2 dB max.
Frequency range	5 - 790 MHz	5 - 862 MHz	6 - 862 MHz
Insertion loss	1 dB typ.		
Return loss	≥ 10 dB		
Stop band	820 - 1000 MHz		
Rejection	50 dB typ.		

All Funke products are provided with all required certifications and markings:





FUNKE DIGITAL TV

Industrieweg 8
5281 RW Boxtel

+31 (0)411 672 440
ms@funke.nl

Product Catalogue Edition 2015/2016

www.funke.nl