

PeakTech®

Unser Wert ist messbar...



PeakTech® 1885 / 1890

**Bedienungsanleitung /
Operation manual**

**Programmierbare DC-Schaltnetzteile /
Programmable Switching Mode Power**

Inhalt

1. Wichtige Sicherheitshinweise	3
2. Technische Spezifikation der Netzteil-Serie	4
3. Einleitung.....	5
4. Bedien- und Anzeigeelemente	5
5. Allgemeines Arbeitsprinzip	6
5.1. Schnellübersicht der Tastenfeldfunktionen	6
6. Bedienungsanleitung	7
6.1. Einstellen des Betriebsmodus	7
6.1.1. Ausgang Ein/Aus	7
6.1.2. Tastenfeld und Drehschalter sperren/entsperren	7
6.1.3. Auswahl der PC-Schnittstelle RS-485	7
6.1.4. Einstellen der oberen Spannungsgrenze	7
6.1.5. Ausgang beim Einschalten Ein/Aus	8
6.1.5. Helligkeit der LCD Anzeige	8
6.1.5. SCPI Funktion aktivieren / deaktivieren	8
6.2. Grundfunktionen	9
6.2.1. Einstellen von Spannung & Strom über Drehschalter & UP-/DN-Tasten ...	9
6.2.2. Einstellen von Spannung & Strom über Tastenfeld	9
6.3. Verwenden der Programmierfunktionen	10
6.3.1. Zeitprogrammierung	10
6.3.2. Programmlauf starten	11
6.3.4. Auswählen der Voreinstellung	11
7. PC-Schnittstelle	12
8.1. Anschließen eines einzelnen Netzteils an den PC über RS-485	12
8.2. Anschlussdiagramm für mehrere Netzteile	12
Anhänge	
Anhang A - Befehlssatz	13

1. Sicherheitsvorkehrungen

Dieses Produkt erfüllt die Anforderungen der folgenden Richtlinien der Europäischen Union zur CE-Konformität: 2014/30/EU (Elektromagnetische Verträglichkeit), 2014/35/EU (Niederspannung), 2011/65/EU (RoHS).

Wir bestätigen hiermit, dass dieses Produkt die wesentlichen Schutzstandards der UKCA erfüllt, die in den Anweisungen des Rates zur Anpassung der Verwaltungsvorschriften für das Vereinigte Königreich von Electromagnetic Compatibility Regulations 2016 und der Electrical Equipment (Safety) Regulations 2016 angegeben sind.



Zur Betriebssicherheit des Gerätes und zur Vermeidung von schweren Verletzungen durch Strom- oder Spannungsüberschläge bzw. Kurzschlüsse sind nachfolgend aufgeführte Sicherheitshinweise zum Betrieb des Gerätes unbedingt zu beachten.

Schäden, die durch Nichtbeachtung dieser Hinweise entstehen, sind von Ansprüchen jeglicher Art ausgeschlossen.

- * Dieses Gerät darf nicht in hochenergetischen Schaltungen verwendet werden
- * Vor Anschluss des Gerätes an eine Steckdose überprüfen, dass die Spannungseinstellung am Gerät mit der vorhandenen Netzspannung übereinstimmt
- * Gerät nur an Steckdosen mit geerdetem Schutzleiter anschließen
- * Gerät nicht auf feuchten oder nassen Untergrund stellen.
- * Ventilationsschlitze im Gehäuse unbedingt freihalten (bei Abdeckung Gefahr eines Wärmestaus im Inneren des Gerätes)
- * Keine metallenen Gegenstände durch die Ventilationsschlitze stecken.
- * Keine Flüssigkeiten auf dem Gerät abstellen (Kurzschlussgefahr beim Umkippen des Gerätes)
- * Gerät nicht in der Nähe starker magnetischer Felder (Motoren, Transformatoren usw.) betreiben
- * Nehmen Sie das Gerät nie in Betrieb, wenn es nicht völlig geschlossen ist.
- * Defekte Sicherungen nur mit einer dem Originalwert entsprechenden Sicherung ersetzen. Sicherung oder Sicherungshalter **niemals** kurzschließen.
- * Gerät, Prüflleitungen und sonstiges Zubehör vor Inbetriebnahme auf eventuelle Schäden bzw. blanke oder geknickte Kabel und Drähte überprüfen. Im Zweifelsfalle keine Messungen vornehmen.
- * Verwenden Sie ausschließlich 4mm-Sicherheitstestkabelsätze, um eine einwandfreie Funktion des Gerätes zu gewährleisten.
- * Messarbeiten nur in trockener Kleidung und vorzugsweise in Gummischuhen bzw. auf einer Isoliermatte durchführen.
- * Messspitzen der Prüflleitungen nicht berühren.
- * Warnhinweise am Gerät unbedingt beachten.
- * Gerät darf nicht unbeaufsichtigt betrieben werden
- * Gerät keinen extremen Temperaturen, direkter Sonneneinstrahlung, extremer Luftfeuchtigkeit oder Nässe aussetzen.
- * Starke Erschütterung vermeiden.
- * Heiße Lötpistolen aus der unmittelbaren Nähe des Gerätes fernhalten.
- * Vor Aufnahme des Messbetriebes sollte das Gerät auf die Umgebungstemperatur stabilisiert sein (wichtig beim Transport von kalten in warme Räume und umgekehrt)
- * Messungen von Spannungen über 35V DC oder 25V AC nur in Übereinstimmung mit den relevanten Sicherheitsbestimmungen vornehmen. Bei höheren Spannungen können besonders gefährliche Stromschläge auftreten.
- * Säubern Sie das Gehäuse regelmäßig mit einem feuchten Stofftuch und einem milden Reinigungsmittel. Benutzen Sie keine ätzenden Scheuermittel.
- * Dieses Gerät ist ausschließlich für Innenanwendungen geeignet.
- * Vermeiden Sie jegliche Nähe zu explosiven und entflammaren Stoffen.
- * Öffnen des Gerätes und Wartungs – und Reparaturarbeiten dürfen nur von qualifizierten Service-Technikern durchgeführt werden.
- * Gerät nicht mit der Vorderseite auf die Werkbank oder Arbeitsfläche legen, um Beschädigung der Bedienelemente zu vermeiden.
- * Keine technischen Veränderungen am Gerät vornehmen.

Reinigung des Gerätes:

Vor dem Reinigen des Gerätes, Netzstecker aus der Steckdose ziehen. Gerät nur mit einem feuchten, fusselfreien Tuch reinigen. Nur handelsübliche Spülmittel verwenden.

Beim Reinigen unbedingt darauf achten, dass keine Flüssigkeit in das Innere des Gerätes gelangt. Dies könnte zu einem Kurzschluss und zur Zerstörung des Gerätes führen.

2. Technische Spezifikation der Netzteile

Technische Daten	P 1890	P 1885
Ausgangsspannung	1-20 V DC	1-40 V DC
Ausgangsstrom	0-10 A	0-5 A
Nennausgangsleistung	200 W	
Geräuschspannung (Spitze-Spitze)	30 mV _{p-p}	
Lastregelung	300 mV	200mV
Spannungsregelung	10 mV	
Eingangsspannung	100-240 V AC, 50/60 Hz	
Max. Eingangsleistung	285 W	
Leistungsfaktor	≥ 0,9	
Display	4-stellig – Multifunktions-LCD-Display (Strom-, Spannungs- und Leistungsmesser)	
Genauigkeit	(+/- 1% + 5 Counts für Bereich V < 5V, I < 0,5A), (+/- 1% + 2 Counts für Bereich V ≥ 5V, I ≥ 0,5A)	
LCD-Maße	48 x 66 mm	
Kühlung	Thermostat geregelter Lüfter	
Betriebstemperatur	0- 40°C	
Schutz	- Überspannungsschutz, - Strombegrenzung, - Übertemperaturschutz.	
Zulassungen	CE EMC -- EN 55011, CE LVD -- EN 61010	
Maße (BxHxT)	193 x 98 x 215 (mm)	
Gewicht	3kg	
Zubehör	- Benutzerhandbuch, - PC Windows® Software, Befehlssatz, LabView® Treiber, - USB-Kabel, RS-485-Anschluss und ein 120 Ohm Widerstand	
Optionales Zubehör	- RS-485-Adapter	
Anmerkung	- einstellbare Spannungsobergrenze, - Blindstromkompensation.	

Spezifikationen zur Fernprogrammierung

Kommunikationsschnittstelle	USB (ein Netzteil) und RS-485 (bis zu 31 Netzteile).
Fernprogrammierungsfunktionen	Volle Steuerung der Netzteilfunktionen
Data Logging-Funktion	Ja, mit mitgelieferter Software.
Baudrate	9600bps

Vorsichtsmaßnahmen für den Gebrauch

1. Das Gerät verfügt über eine integrierte O.V.P-Funktion (Überspannungsschutz). Wenn die Ausgangsspannung 10% über dem eingestellten Wert liegt, wird die O.V.P. ausgelöst und die Ausgangsleistung wird abgeschaltet und es erscheint die Warnung > FAULT <.

Wenn Sie diese Warnung erhalten, schalten Sie das Gerät aus und entfernen Sie alle Lasten.

Schalten Sie das Gerät wieder ein und es sollte wieder normal funktionieren.

Falls das Problem weiterhin besteht, muss das Gerät von einem Techniker untersucht werden.

2. In diesem Gerät ist ein Summer eingebaut. Der Summer ertönt, wenn Übertemperatur / Überlast / Überspannung ausgelöst wurde.

Wenn Sie diesen Warnton hören, schalten Sie das Gerät aus und entfernen Sie alle Lasten.

Überprüfen Sie Ihre Last- und Ausgabeeinstellungen. Lassen Sie das Gerät 30 Minuten abkühlen.

Wenn Sie das Gerät erneut einschalten, sollte es den normalen Betrieb wieder aufnehmen.

Wenn das Problem weiterhin besteht, muss das Gerät von einem Techniker untersucht werden.

3. Einleitung

Diese Serie an programmierbaren Schaltnetzteilen wurde für die komplette Fernprogrammierung mit Data Logging-Funktion entwickelt. Über eine RS-485-Schnittstelle können bis zu 31 Netzteile angeschlossen werden. Das ist ideal für Anwendungen insbesondere mit mehreren Netzteilen, die unterschiedliche Gruppen an Ausgangseinstellungen und Laufzeiten für sich wiederholende Testungen erfordern.

Als Einzel-Labornetzgerät kann der Benutzer mithilfe des Anzeigefeldes alle Programmierungen und Ausgangseinstellungen vornehmen.

Dieses Handbuch liefert komplette Befehlssätze zur Vereinfachung der Integration Ihrer eigenen Steuerungssoftware. Diese Netzteil-Serie erfüllt die Sicherheitsnorm EN-61010 und EN-55011 EMV für wissenschaftliche, industrielle Geräte gemäß den EU-Richtlinien.

Bewahren Sie dieses Handbuch an einem sicheren Ort auf und wenden Sie sich bei Bedarf von optionalem Zubehör für RS-485 an Ihren Händler.

HINWEIS:

Labornetzgeräte sind nicht zum Laden von Batterien konzipiert. Eine solche Benutzung kann zu schwerwiegenden Beschädigungen am Gerät führen, welche von Ansprüchen jeglicher Art ausgeschlossen sind.

4. Bedien- und Anzeigeelemente

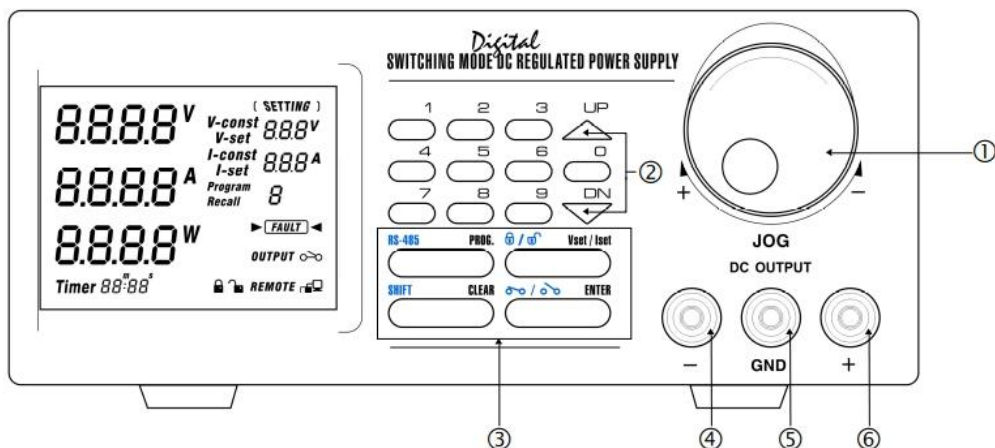

1. Drehschalter (JOG)
2. Auf- & Ab-Tasten (UP/DN)
3. Dualfunktions-Steuertasten
4. Ausgangsbuchse Minus (Blau)
5. Ausgangsbuchse GND (Grün) (an Gehäuse angeschlossen).
6. Ausgangsbuchse Plus (Rot)

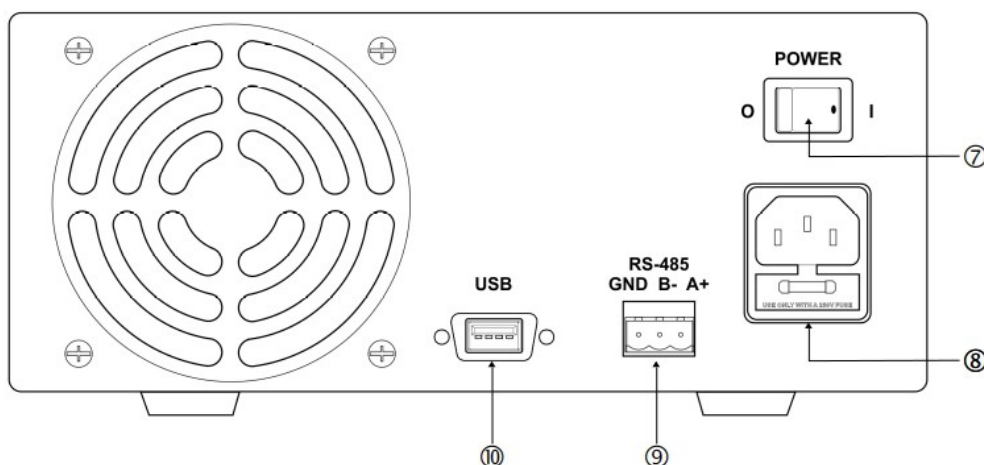

7. Ein-/Aus-Schalter
8. AC 100-240 V AC Steckdose mit Eingangssicherung.
9. USB Port
10. RS-485 Port

5. Allgemeines Arbeitsprinzip











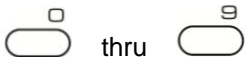



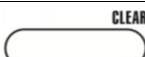
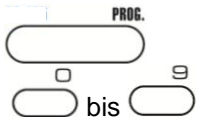







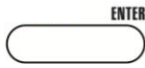

Hinweis: Dieser Abschnitt enthält einen zusammenfassenden Überblick über das Gerät. Lesen Sie diesen Abschnitt, wenn Sie schnell starten möchten.

5.1. Schnellübersicht der Tastenfeldfunktionen

Das vorderseitige Tastenfeld ist folgendermaßen angeordnet:

- (1) Zifferntasten, UP/DOWN-Tasten und Drehschalter
- (2) 4 Dualfunktions-Steuertasten

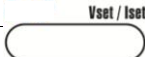

Die Anzeigefeldfunktionen lassen sich folgendermaßen zusammenfassen:

Tasten	Funktion	Abschnitt
Nummerntasten, AUF/AB Tasten und Drehrad		
	Drücken für numerischen Werte	6.2.2
	Drücken zum erhöhen numerischer Werte	6.2.1
	Drücken zum verringern numerischer Werte	6.2.1
Jog Wheel	Drehen zum ändern von Strom- und Spannungswerten	6.2.1
Duale Funktionstasten		
	Shift drücken für zweite Funktionsebene der Tasten	
	Jegliche Eingabe beenden und zur normalen Funktion zurück	
	Voreingestellte Programmfunktionen aufrufen Nutzen Sie  um voreingestellte Programme zu beenden Nutzen Sie  bis  um den Speicherort des voreingestellten Programms auszuwählen und  zur Bestätigung	6.3.1 6.3.3
	Drücken Sie  und  für das RS-485 Menü	6.1.3
	Drücken Sie  und  um die Tastensperre zu aktivieren / deaktivieren	6.1.2
	Zum bestätigen der durchgeführten Einstellungen drücken	
	Drücken Sie  und  um den Ausgang ein- und auszuschalten	6.1.1
	Ausgang beim Einschalten aktivieren	6.1.5
	Ausgang beim Einschalten deaktivieren	6.1.5
Spezialfunktion		
	Maximale Spannungsbegrenzung festlegen Nutzen Sie  bis  für die Eingabe numerischer Werte Drücken Sie  zur Bestätigung	6.1.4
	Einstellung zwischen Spannung (Vset) und Strom (Iset) umschalten	

6. Bedienungsanleitung

6.1. Einstellen des Betriebsmodus

6.1.1. Ausgang Ein/Aus

	Aktion	LCD-Display	Beschreibung
1.	<input type="text" value="SHIFT"/> drücken		Ausgang AKTIVIERT
2.	<input type="text" value="O/P ON/OFF"/> drücken		Ausgang DEAKTIVIERT

6.1.2. Tastenfeld und Drehschalter sperren/entsperren

	Aktion	LCD-Display	Beschreibung
1.	<input type="text" value="SHIFT"/> drücken		Tastenfeld und Drehschalter gesperrt.
2.	<input type="text" value="LOCK/UNLOCK"/> drücken		Tastenfeld und Drehschalter entsperrt.

6.1.3. Auswahl der PC-Schnittstelle RS-485

	Aktion	LCD-Display	Beschreibung
1.	Erst <input type="text" value="SHIFT"/> dann <input type="text" value="RS-485"/> drücken	485 001	Zugriff auf Auswahl der RS-485 Adresse
2.	<input type="text" value="0"/> bis <input type="text" value="9"/>		Adresse von 1 bis 255 mit numerischen Tasten festlegen
3.	<input type="text" value="ENTER"/> drücken		Zur Bestätigung diese Taste drücken.



Hinweis: Durch Drücken von "CLEAR" können Sie jederzeit die Einstellung des Betriebsmodus beenden zum normalen Betrieb zurückkehren.

6.1.4. Einstellen der Spannungsobergrenze







	Aktion	LCD-Display	Beschreibung
1.	Erst <input type="text" value="SHIFT"/> dann <input type="text" value="0"/> drücken	OVER V 25,6	Zugriff auf die Einstellung der Spannungsobergrenze. In diesem Beispiel ist die aktuelle Spannungsobergrenze 25,6 V.
2.	<input type="text" value="0"/> bis <input type="text" value="9"/>		Zur Eingabe der gewünschten Spannung.
3.	<input type="text" value="ENTER"/> drücken		Zur Bestätigung diese Taste drücken.

Hinweis: Durch Drücken von "CLEAR" können Sie jederzeit die Einstellung der Spannungsobergrenze beenden und zum normalen Betrieb zurückkehren.

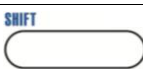
6.1.5. Ausgang beim Einschalten Ein/Aus

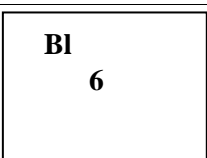
	Aktion	LCD-Display	Beschreibung
1.	Erst  dann ▲ UP drücken	PrUP ON (Ein)	Dies aktiviert den Ausgang beim Einschalten des Geräts, d.h. wenn Sie das Netzteil einschalten, ist der Ausgang ebenfalls automatisch AN und zeigt den zuletzt eingestellten Spannungswert.
2.	Dann  und ▼ DN	PrUp OFF (Aus)	Dies deaktiviert den Ausgang beim Einschalten des Geräts, d.h. der Ausgang bleibt beim nächsten Einschalten des Geräts AUS. Aus Sicherheitsgründen ist dies die Standardeinstellung!!

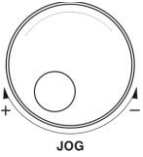
6.1.6 Adjust LCD brightness

	Aktion	LCD-Display	Beschreibung
1.	Drücke  dann 		 und  drücken, um das Helligkeitsmenü der Anzeige zu öffnen
2.	Drehen 		Drehrad zur Auswahl der Helligkeit drehen. 0 bedeutet Hintergrundbeleuchtung aus. 9 bedeutet volle Helligkeit.
3.	Drücke 		Enter zur Bestätigung drücken

6.1.7 Adjust LCD brightness

	Aktion	LCD-Display	Beschreibung
1.	Drücke  dann 		Drücken Sie  und  um das SCPI Menü zu öffnen
2.	Drehen 		Wählen Sie Y oder N (Ja oder Nein) mit dem Drehschalter aus
3.	Drücke 		Enter zur Bestätigung drücken

6.2. Grundfunktionen

6.2.1. Einstellen von Spannung & Strom über Drehschalter und UP-/DN-Tasten

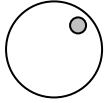
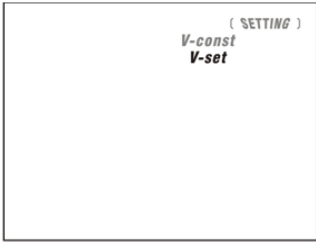
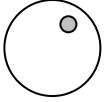
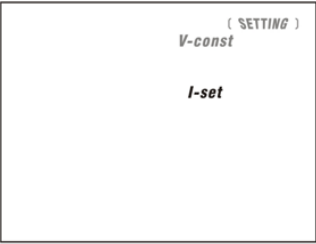
	Aktion	LCD-Anzeige	Beschreibung
1.	<input type="button" value="ENTER"/> drücken		Spannungseinstellung.
2.	Drehen  oder ▲ UP & ▼ DN drücken		Zum Einstellen des Spannungspegels Drehschalter drehen oder UP-/DN-Tasten drücken.
3.	<input type="button" value="ENTER"/> drücken	I-set	Stromeinstellung.
4.	Drehen  oder ▲ UP & ▼ DN drücken		Zum Einstellen des Stroms Drehschalter drehen oder UP-/DN-Tasten drücken.
5.	<input type="button" value="ENTER"/> drücken		Zur Bestätigung diese Taste drücken.



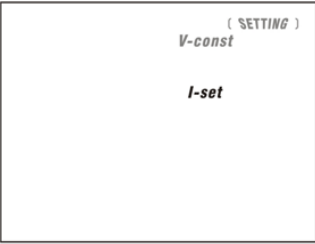





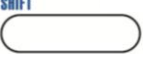

6.2.2. Einstellen von Spannung & Strom über Tastenfeld

	Aktion	LCD-Anzeige	Beschreibung
1.	<input type="button" value="ENTER"/> drücken		Zum Start der Spannungseinstellung diese Taste drücken. Einstellen der Spannung durch Drücken der Zifferntasten des Zahlenfeldes.
2.	Gewünschte Spannung eingeben durch Drücken der Tasten <input type="button" value="0"/> bis <input type="button" value="9"/>		
3.	<input type="button" value="ENTER"/> drücken		Zum Start der Stromeinstellung diese Taste drücken. Einstellen des Stroms durch Drücken der Zifferntasten des Zahlenfeldes.
4.	Gewünschten Strom eingeben durch Drücken der Tasten <input type="button" value="0"/> bis <input type="button" value="9"/>		
5.	<input type="button" value="ENTER"/> drücken		Zur Bestätigung der Spannungs- und Stromeinstellungen Enter drücken.

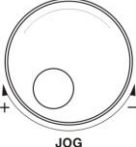
Hinweis: Durch Drücken von "CLEAR" können Sie jederzeit die Einstellung von Spannung und Strom beenden und zum normalen Betrieb zurückkehren.



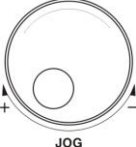

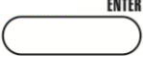





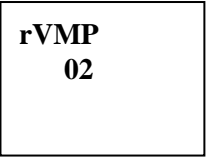

6.3. Verwenden der Programmierfunktionen

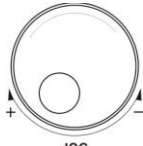
6.3.1. Zeitprogrammierung

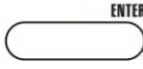
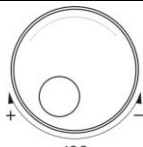
	Aktion	LCD-Anzeige	Beschreibung
1.	Drücke  dann 		Drücken Sie  und  zur Eingabe der Stufe für das Zeitprogramm.
2.	Nutze oder  bis 		Drehrad oder numerische Tasten nutzen, um die Stufe des Zeitprogramm auszuwählen.
3.	drücke  und 		Up und Down Tasten nutzen, um die verschiedenen Einstellungen des Zeitprogramms durchzuschalten. Der ausgewählte Teil blinkt als Indikation zur Änderung.
4.	Nutze oder  bis 		Drehrad oder numerische Tasten zur Einstellung der Strom-, Spannungs- oder Zeitwerte nutzen.
5.	Drücke 		Enter zur Bestätigung drücken.



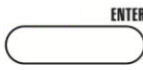







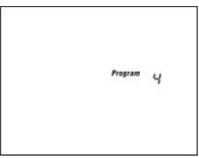

Hinweis: Durch Drücken von "CLEAR" können Sie jederzeit das Zeitprogramm beenden und zum normalen Betrieb zurückkehren.

6.3.2. Programmlauf starten

	Action	LCD Display	Description
1.	Press   Then 		Press  and  to enter in run menu.
2.	Use  or  thru 		Use JOG or numbering keypad select number of steps to be run start from step 0. The minimum steps to be run is 2.
3.	Press 		Press this key next to set number of cycle to be run.
4.	Use  or  thru 		Use JOG or numbering keypad select number of cycle to be run.
5.	Press 		Press this key to start running
6.			Press this key terminate the program running anytime.

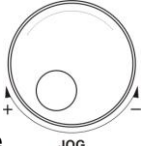
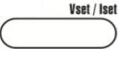
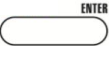
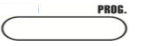
Hinweis: Durch Drücken von "CLEAR" können Sie jederzeit das Zeitprogramm beenden und zum normalen Betrieb zurückkehren.

6.3.4. Auswählen der Voreinstellung

	Aktion	LCD-Anzeige	Beschreibung
1.	Drücke  dann  bis 		Drücken Sie  und dann  bis  um die Voreinstellung auszuwählen. z.B.  +  für die Voreinstellung 4
2.	Drehe  und 		Drehrad für die V- und I-Einstellung des Preset einzusetellen, wenn gewünscht
3.	Drücke 		Taste zur Bestätigung drücken
4.	Drücke  dann 		Drücken Sie  und  um das Voreinstellungsprogramm zu verlassen.

Hinweis: Durch Drücken von "CLEAR" können Sie jederzeit die Auswahl von Voreinstellungen beenden und zum normalen Betrieb zurückkehren.

7. Bedienungsanleitung PC-Schnittstelle

Dieser Abschnitt zeigt den Anschluss von:
einem Netzteil über die RS-232-Schnittstelle
2 oder mehr (bis zu 31) Netzteilen über die RS-485-Schnittstelle.

7.1. Anschließen mehrerer Netzteile an den PC über RS-485

Verwenden Sie bei mehreren anzuschließenden Netzteilen die RS-485-Schnittstelle über den RS-485-Anschluss auf der Rückseite der Netzteile. Bis zu 31 Netzteile können über die RS-485-Schnittstelle angeschlossen werden.

Sie benötigen ein USB zu RS-485-Adapter (optionales Zubehör) und die in den Abbildungen unten dargestellten Anschlussanordnung.

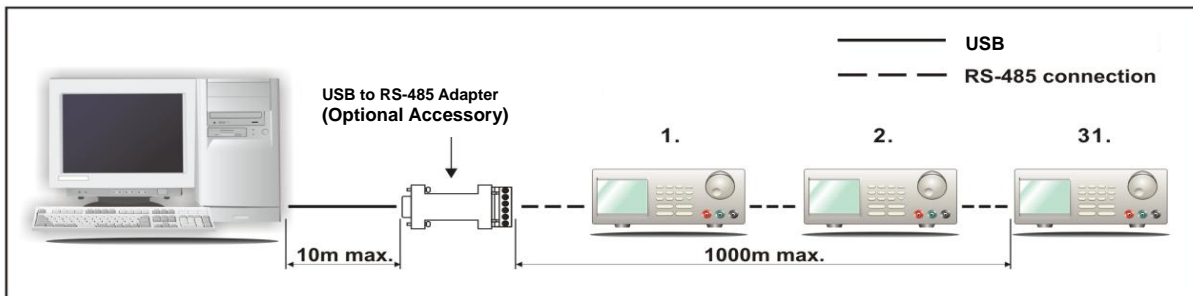

8.2. Anschlussdiagramm für mehrere Netzteile.

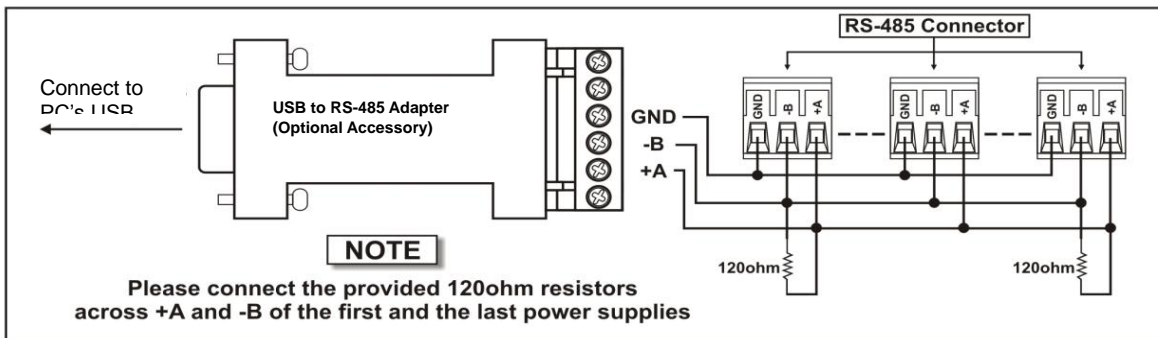

Anschlussdiagramm für Adapter und RS-485-Anschlüsse.

Für mehr Informationen, s. Anhang B und Anhang C.

Anhang

BEFEHLSSATZ

Anmerkungen zur Verwendung des Fernprogrammiermodus

Die USB/485-Schnittstelle ist immer für den Anschluss an einen PC zur Fernprogrammierung bereit.

Befehlssatz

{ }-Befehlsdaten, [] – zurückgegebene Daten, [OK] = "OK", [CR] = 0 dh

???? = 30h, 30h, 30h, 30h - 39h, 39h, 39h, 39h (4 bytes data)

??? = 30h, 30h, 30h - 39h, 39h, 39h (3 bytes data)

?? = 30h, 30h – 39h, 39h (2 bytes data)

Fett – Eingabebefehl

Kursiv – vom Netzteil zurückgegebene Daten

Command Code & Return Data	Description
Input Command: SESS <address> <CR> Return Data from Power Supply: <i>[OK] [CR]</i>	Disable front panel keypad and make PS to Remote Mode
Input Command: ENDS <address> <CR> Return Data from Power Supply: <i>[OK] [CR]</i>	Enable front panel keypad and make PS to exit Remote Mode
Input Command: CCOM <address> <RS> {000-256} <CR> Return Data from Power Supply: <i>[OK] [CR]</i>	Change RS485 <RS> = 0 -> RS-232 <RS> = 1 -> RS-485
Input Command: GCOM <address> <CR> Return Data from Power Supply: <i>[RS] RS485 Address [??] [CR]</i> <i>[OK] [CR]</i>	Get the RS-485 address
Input Command: GMAX <address> <CR> Return Data from Power Supply: <i>Voltage [???] Current [???] [CR]</i> <i>[OK] [CR]</i>	Get maximum voltage and current of PS
Input Command: GOVP <address> <CR> Return Data from Power Supply: <i>Voltage [???] [CR]</i> <i>[OK] [CR]</i>	Get Upper Voltage Limit of PS
Input Command: GETD <address> <CR> Return Data from Power Supply:	Get Voltage & Current reading from PS

Command Code & Return Data	Description
<p><i>Voltage [????] Current [????] [0] [CR]</i> <i>[OK] [CR]</i></p> <p><i>Voltage [????] Current [????] [1] [CR]</i> <i>[OK] [CR]</i></p>	<p>PS in CV mode</p> <p>PS in CC mode</p>
<p>Input Command: GETS <address> <CR></p> <p>Return Data from Power Supply:</p> <p><i>Voltage [???] Current [???] [CR]</i> <i>[OK] [CR]</i></p>	<p>Get Voltage & Current Set Value from PS</p>
<p>Input Command: GETM <address> <CR></p> <p>Return Data from Power Supply:</p> <p><i>Memory 1 Voltage [???] Current [???] [CR]</i> <i>Memory 2 Voltage [???] Current [???] [CR]</i> . . . <i>Memory 9 Voltage [???] Current [???] [CR]</i> <i>[OK] [CR]</i></p>	<p>Get All Preset Memory Values from PS</p>
<p>Input Command: GETM <address> location {1-9} <CR></p> <p>Return Data from Power Supply:</p> <p><i>Voltage [???] Current [???] [CR]</i> <i>[OK] [CR]</i></p>	<p>Get Memory from Specific Preset of PS</p>
<p>Input Command: GETP <address> <CR></p> <p>Return Data from Power Supply:</p> <p><i>Program 00 Voltage [???] Current [???] Minute [??] Second [??] [CR]</i> <i>Program 01 Voltage [???] Current [???] Minute [??] Second [??] [CR]</i> . . . <i>Program 19 Voltage [???] Current [???] Minute [??] Second [??] [CR]</i> <i>[OK] [CR]</i></p>	<p>Get all the Timed Program Memory of PS</p>
<p>Input Command: GETP <address> program {00-19} <CR></p> <p>Return Data from Power Supply:</p> <p><i>Voltage [???] Current [???] Minute [??] Second [??] [CR]</i> <i>[OK] [CR]</i></p>	<p>Get Timed Program Memory from Specific Program of PS</p>
<p>Input Command: GPAL <address> [CR]</p> <p>Return Data from Power Supply:</p> <p><i>Reading voltage [#####] V [ON]</i> <i>Reading current [#####] A [ON]</i> <i>Reading watt [#####] W [ON]</i></p>	<p>Get LCD Display Information</p>

Command Code & Return Data	Description
<p><i>Timer minute [#####] second [###] timer [ON] colon [ON] m [ON] s [ON] Setting voltage [###] V-const [ON] V-bar [ON] V [ON] Setting current [###] I-Const [ON] I-bar [ON] A [ON] Program [#] Program [ON] P-bar [ON] SETTING [ON] Key lock [ON] Key open [ON] FAULT [ON] Output on [ON] Output off [ON] Remote [ON] [CR] [OK] [CR]</i></p>	
<p>Input Command: VOLT <address> voltage {000-XXX} <CR></p> <p>Return Data from Power Supply: [OK] [CR]</p>	<p>Set Voltage Level XXX-Max. Output Rating Voltage = XX.X V Current = X.XX V</p>
<p>Input Command: CURR <address> current {000-XXX} <CR></p> <p>Return Data from Power Supply: [OK] [CR]</p>	<p>Set Current Level</p>
<p>Input Command: SOVP <address> voltage {000-XXX} <CR></p> <p>Return Data from Power Supply: [OK] [CR]</p>	<p>Set Upper Voltage Limit of PS</p>
<p>Input Command: SOUT <address> 1 <CR></p> <p>Return Data from Power Supply: [OK] [CR]</p>	<p>Disable Output of PS</p>
<p>Input Command: SOUT <address> 0 <CR></p> <p>Return Data from Power Supply: [OK] [CR]</p>	<p>Enable Output of PS</p>
<p>Input Command: POWW <address> location {1-9}0 <CR></p> <p>Return Data from Power Supply: [OK] [CR]</p>	<p>Enable the output when switch on the power supply.</p>
<p>Input Command: POWW <address> location {1-9}1 <CR></p> <p>Return Data from Power Supply: [OK] [CR]</p>	<p>Disable the output when switch on the power supply.</p>
<p>Input Command: PROM <address> location {1-9} Voltage {000-XXX} Current {000-XXX} <CR></p> <p>Return Data from Power Supply: [OK] [CR]</p>	<p>Set Voltage and Current values of Preset Memory</p>
<p>Input Command: PROP <address> location {00-19} Voltage {000-XXX} Current {000-XXX}</p>	<p>Set Voltage, Current</p>

Command Code & Return Data	Description
Minute {00-99} Second {00-59} <CR> Return Data from Power Supply: [OK] [CR]	and Time period of Timed Program
Input Command: RUNM <address> location {1-9} <CR> Return Data from Power Supply: [OK] [CR]	Recall Preset Memory 1-9
Input Command: RUNP <address> times {000-256} <CR> Return Data from Power Supply: [OK] [CR]	Run Timed Program (000 = run infinite times)
Input Command: STOP <address> <CR> Return Data from Power Supply: [OK] [CR]	Stop Timed Program

Alle Rechte, auch die der Übersetzung, des Nachdruckes und der Vervielfältigung dieser Anleitung oder Teilen daraus, vorbehalten.

Reproduktionen jeder Art (Fotokopie, Mikrofilm oder ein anderes Verfahren) nur mit schriftlicher Genehmigung des Herausgebers gestattet.

Letzter Stand bei Drucklegung. Technische Änderungen des Gerätes, welche dem Fortschritt dienen, vorbehalten.

Hiermit bestätigen wir, dass alle Geräte, die in unseren Unterlagen genannten Spezifikationen erfüllen und werkseitig kalibriert geliefert werden. Eine Wiederholung der Kalibrierung nach Ablauf von 1 Jahr wird empfohlen.

Table of Contents

1. Safety precautions	18
2. Technical specifications	19
3. Introduction	19
4. Controls and indicators	20
5. General operation principle	21
5.1. Quick reference of keypad functions	21
6. User manual	22
6.1. Operation modes	22
6.1.1. Output ON/OFF	22
6.1.2. Lock/ Unlock the Keypad and Jog Dial	22
6.1.3. RS-485 Address setting	22
6.1.4. Upper voltage limit setting	22
6.1.5. Output Enable/Disable at Power Up.....	23
6.1.6. Adjust LCD brightness	23
6.1.7. Enable/disable SCPI function	24
6.2. Basic Operation	24
6.2.1. Setting of Voltage and Current by Jog Dial and UP & DOWN Key.....	24
6.2.2. Setting of Voltage and Current Using Keypad	25
6.3. Using the Programming Features	25
6.3.1. Preset Program	25
6.3.2. Setting of Timed Program.....	26
6.3.4. Run Timed Programming.....	26
7. PC-Connection	27
8.1. Connect Multiple Power Supplies to PC via RS-485.....	27
8.2. Connection diagram for multiple power supply.....	27
APPENDIX	
Appendix A – Command Set	28

1. Safety Precautions

This product complies with the requirements of the following directives of the European Union for CE conformity: 2014/30/EU (electromagnetic compatibility), 2014/35/EU (low voltage), 2011/65/EU (RoHS).

We herewith confirm that this product meets the essential protection standards, which are given in directions of council for adaptation of the administration regulations for UK of Electromagnetic Compatibility Regulations 2016 and the Electrical Equipment (safety) regulations 2016.



To ensure safe operation of the equipment and eliminate the danger of serious injury due to short-circuits (arcing), the following safety precautions must be observed.

Damages resulting from failure to observe these safety precautions are exempt from any legal claims whatever.

- * Do not use this instrument for high-energy industrial installation measurement.
- * Prior to connection of the equipment to the mains outlet, check that the available mains voltage correspond to the voltage setting of the equipment.
- * Connect the mains plug of the equipment only to a mains outlet with earth connection.
- * Do not place the equipment on damp or wet surfaces.
- * Do not cover the ventilations slots of the cabinet to ensure that air is able to circulate freely inside.
- * Do not insert metal objects into the equipment by the way of ventilation slots
- * Do not place water-filled containers on the equipment (danger of short-circuit in case of knockover of the container)
- * Do not operate the equipment near strong magnetic fields (motors, transformers etc.).
- * Do not operate the meter before the cabinet has been closed and screwed safely as terminal can carry voltage.
- * Replace a defective fuse only with a fuse of the original rating. Never short-circuit fuse or fuse holding.
- * Check test leads and probes for faulty insulation or bare wires before connection to the equipment.
- * Please use only 4mm-safety test leads to ensure immaculate function.
- * To avoid electric shock, do not operate this product in wet or damp conditions. Conduct measuring works only in dry clothing and rubber shoes, i. e. on isolating mats.
- * Never touch the tips of the test leads or probe.
- * Comply with the warning labels and other info on the equipment.
- * The measurement instrument is not to be operated unattended.
- * Do not subject the equipment to direct sunlight or extreme temperatures, humidity or dampness.
- * Do not subject the equipment to shocks or strong vibrations.
- * Keep hot soldering irons or guns away from the equipment.
- * Allow the equipment to stabilize at room temperature before taking up measurement (important for exact measurements).
- * Use caution when working with voltages above 35V DC or 25V AC. These Voltages pose shock hazard.
- * Periodically wipe the cabinet with a damp cloth and mild detergent. Do not use abrasives or solvents.
- * The meter is suitable for indoor use only
- * Do not store the meter in a place of explosive, inflammable substances.
- * Opening the equipment and service – and repair work must only be performed by qualified service personnel
- * Do not place the equipment face-down on any table or work bench to prevent damaging the controls at the front.
- * Do not modify the equipment in any way

Cleaning the cabinet:

Prior to cleaning the cabinet, withdraw the mains plug from the power outlet.

Clean only with a damp, soft cloth and a commercially available mild household cleanser. Ensure that no water gets inside the equipment to prevent possible shorts and damage to the equipment.

Precautions For Use

1. The unit has a built-in Tracking O.V.P (Over voltage Protection) features. In the event of output voltage becoming 10% greater than the set value, the O.V.P. will be triggered and the output power will be cut off and >FAULT< warning appears.

When you get this warning , switch off the unit and remove all loading, switch the unit back on again and it should resume normal operation.

In the event this problem persists, the unit must be investigated by your agent.

2. This unit has a buzzer built inside. The buzzer will sound when over temperature/ overload/ over voltage has been triggered.

When you get this warning sound , switch off the unit and remove all loading.

Check your load and output settings.

Allow the unit to cool down for 30 minutes.

If you switch on the unit again, it should resume the normal operation.

In the event of this problem persists, the unit must be investigate by your agent.

2. Technical Specifications of Power Supplies

Specifications	P 1890	P 1885
Output voltage	1-20 V DC	1-40 V DC
Output current	0-10 A	0-5 A
Rated Output Power	200 W	
Ripple & Noise (p-p)	30 mV _{p-p}	
Load Regulation	300 mV	200mV
Line Regulation	10 mV	
Input Voltage	100-240 V AC, 50/60 Hz	
Max. Input Power	285 W	
Power Factor	≥ 0,9	
Display Meter	4 digits – Display LCD Ammeter, Voltmeter and Power Meter	
Meter's Accuracy	(+/- 1% + 5 counts for range V < 5V, I < 0.5A), (+/- 1% + 2 counts for range V ≥ 5V, I ≥ 0.5A)	
LCD Dimension	48 x 66 mm	
Cooling System	Thermostatic Control Fan	
Operating Temperature	0- 40°C	
Protection	-Tracking OVP (Over Voltage Protection), -Current Limiting, -Over Temperature Protection.	
Approvals	CE EMC -- EN 55011, CE LVD -- EN 61010	
Dimension (WxHxD)	193 x 98 x 215 (mm)	
Weight	3kg	
Accessory	-User's Manual, -PC Windows® software, Command Set, LabView® Driver, -USB cable, RS-485 Connector and one 120ohms Resistor	
Optional Accessory	-USB to RS-485 Adapter	
Remarks	-Adjustable Upper Voltage limit, -Power Factor Correction.	

Remote Programming Specifications

Communications Interface	USB (single device) and RS-485 (up to 31 Power Supplies).
Remote Programming Functionality	Full control of power supply functions and data readback.
Data Logging	Yes, with supplied software.
Baud Rate	9600bps

3. Introduction

This series of Programmable Switching Mode Power Supplies are designed for full remote programming with data logging functionality. Up to 31 power supplies can be connected via RS- 485. It is ideal for applications which require various groups of output settings and running periods for repetitive tests especially with multiple power supplies.

The front panel allows users to all programming and output settings as a stand alone laboratory power supply.

Full command sets are given in this manual to facilitate the integration of your own control software.

This series of power supplies have obtained the safety approval EN-61010 and EN-55011 EMC approval for scientific , industrial equipment of the CE directives.

Please keep this manual in a safe place and contact your vendor for any special requirement in optional accessories for RS-485.

NOTE:

Laboratory Power Supplies are not designed for charging batteries. Any use of this type can cause serious damage to the device, which are exempt from any legal claims whatever.

4. Controls and Indicators

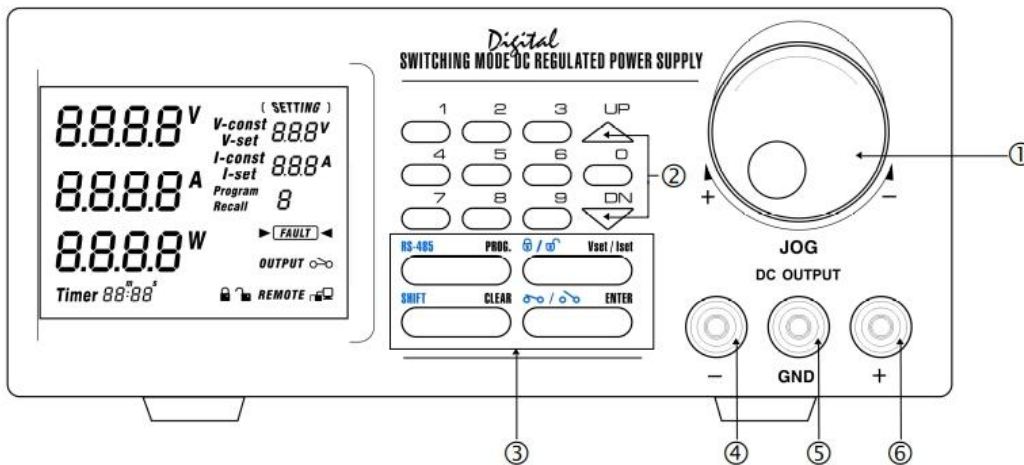

1. Jog Dial
2. Up & Down Key
3. Dual Function Control Key
4. Black colour negative polarity output terminal
5. Green colour ground terminal (connected to chassis).
6. Red colour positive polarity output terminal.

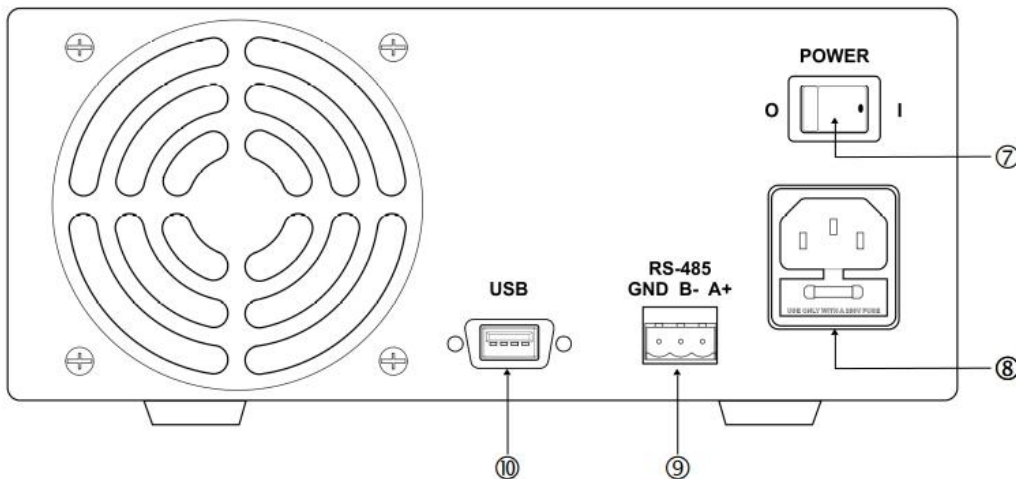

7. Power Switch
8. AC 100-240 V AC Power Socket with input power fuse.
9. RS-232 Port
10. RS-485 Port

5. General Operation Principle











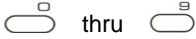



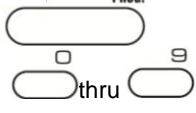



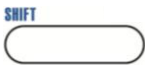

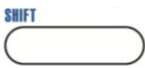
Note: This section contains a condensed overview of the unit. Read this section to quickly get started.

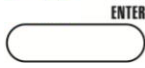
5.1 Quick Reference of Keypad Functions

The front Keypad is organised as follow:

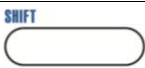
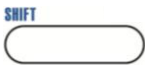
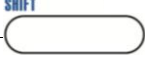
- (1) Number Keys, UP/DOWN Keys and Jog Wheel
- (2) 4 Dual Function Control Keys









The front panel functions are summarized as follow:

Keypad	Function	Section
Number Keys, UP/DOWN Keys and Jog Wheel		
	Press to select numerical values	6.2.2
	Press to ascend the numerical values	6.2.1
	Press to descend the numerical values	6.2.1
Jog Wheel	Rotate to adjust the voltage and current settings	6.2.1
Dual Function Control Keys		
	Press to access second function of the control keys	
	Press to terminate any input process and the unit will exit to normal operation	
	Press to use recall preset program features. Use  to exit the use of any preset program Use  thru  to specify the location of preset program to be used Use  to confirm	6.3.1 6.3.3
	Press  and  to enter RS-485 set menu	6.1.3
	Press  and  to Lock/Unlock the Keypad and Jog Wheel	6.1.2
	Press to confirm the new settings	
	Press  and  to Enable/Disable the output	6.1.1
	Press to Enable the output at power up	6.1.5
	Press to Disable the output at power up	6.1.5
SPECIAL Function		
	Press to get to the Upper Voltage Limit Setting Use  thru  to input the numerical values Use  to confirm	6.1.4
	Switch between set output Voltage and output Current	

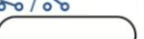







6. User Manual

6.1 Setting Operation Modes





6.1.1. Enable/Disable Output

	Action	LCD Display	Description
1.	Press   Then 	OUTPUT 	Output ENABLE
2.	Press   Then 	OUTPUT 	Output DISABLE



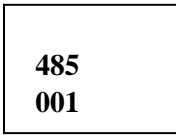

6.1.2 Lock/ Unlock the Keypad and Jog Dial

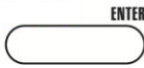
	Action	LCD Display	Description
1.	Press   Then 		Keypad and Jog Dial Locked
2.	Press   Then 		Keypad and Jog Dial UnLocked

6.1.3 RS-485 address setting



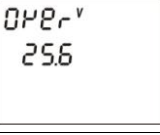

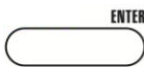

	Action	LCD Display	Description
1.	Press   Then 		This will enter into RS-485 address set menu.
2.			Use numbering keypad to key in address from 1 to 255 for RS-485 connection
3.	Press 		Press this key to confirm

6.1.4 Upper Voltage Limit Setting





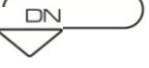

	Action	LCD Display	Description
1.	Press   Then 		This will enter into Upper Voltage Limit Adjustment. e.g. 25.6V present upper voltage limit.
2.			Use the number key to input your desired voltage
3.	Press 		Press this key to confirm

Note : Whenever to terminate the Upper Voltage Limit Setting, press “CLEAR” to return to normal operation.



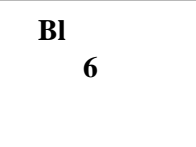

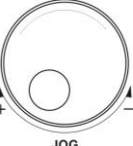
6.1.5 Output Enable/Disable at Power Up

	Action	LCD Display	Description
1.	Press  Then 		This will enable the output at power up. i.e. When you switch on the power supply, the output is also ON automatically with last set voltage value.
2.	Press  Then 		This will disable the output at power up. i.e. The output will be OFF at next power up. This is the default setting for safety reason !!

6.1.6 Adjust LCD brightness





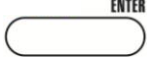

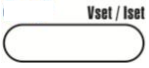

	Action	LCD Display	Description
1.	Press  Then 		Press  and  to enter into brightness set menu.
2.	 Rotate		Use JOG adjust LCD brightness. It has 10 level of brightness. 0 means LCD brightness off. 9 means the most brightest.
3.	Press 		Press this key to confirm

6.1.7 Enable/Disable SCPI







	Action	LCD Display	Description
1.	Press  Then 		Press  and  to enter into SCPI enable/disable menu
2.	Rotate 		Use JOG select between Y and N
3.	Press 		Press this key to confirm

6.2 Basic Operation

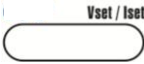
6.2.1 Setting of Voltage and Current by Jog Dial and UP & DOWN Key

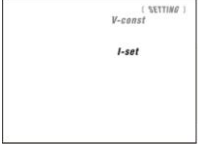
	Action	LCD Display	Description
1.	Press 	 	Press  to switch between V-set and I-set.
2.	Rotate  or Press  and 		Rotate JOG or Press  &  Key to set the voltage/current level. Press Rotate JOG to switch between digit to be adjust.



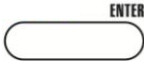







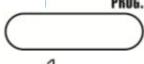

6.2.2 Setting of Voltage and Current Using Keypad

	Action	LCD Display	Description
1.	Press 	 	Press  to switch between V-set and I-set.
2.	 to 		Setting voltage/current by pressing numbers on Keypad.
3.	Press 		Press this key to confirm

Note : whenever to terminate the settings of voltage and current, press “CLEAR” to return to the normal operation.

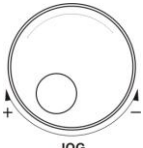
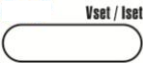
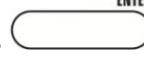
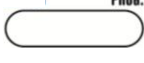











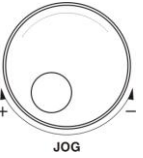

6.3 Using the Programming Features

6.3.1 Preset Program

	Action	LCD Display	Description
1.	Press  Then  thru 		Press  and then  thru  to select Preset program. e.g.  +  to select preset program 4
2.	Use  and 		Use JOG and V-set/I-set adjust Voltage and Current setting if you want to adjust the preset value.
3.	Press 		Press this key to confirm
4.	Press  Then 		Press  and  to exit preset program.

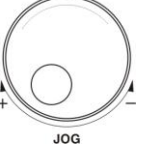







Note : whenever to terminate the Timed Program, press “CLEAR” to return to the normal operation.

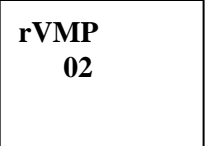

6.3.2 Setting of Timed Program

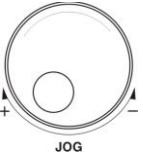
	Action	LCD Display	Description
1.	Press   Then 		Press  and  to enter into timed program step setting.
2.	Use  or  thru 		Use JOG or numbering Keypad to select step to be review.
3.	Press  and 		Use UP/DOWN key to move around voltage, current and time setting of step. The select part will flash to indicate it is under modification.
4.	Use  or  thru 		Use JOG or numbering keypad to modify the voltage, current and time.
5.	Press 		Press this key to confirm

Note : whenever to terminate the Timed Program, press “CLEAR” to return to the normal operation.

6.3.3 Run Timed Programming

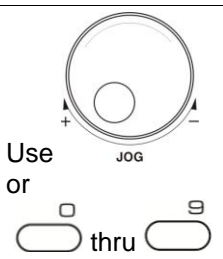
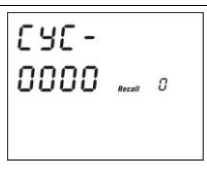
	Action	LCD Display	Description
1.	Press   Then 		Press  and  to enter in run menu.
2.	Use  or  thru 		Use JOG or numbering keypad select number of steps to be run start from step 0. The minimum steps to be run is 2.
3.	Press 		Press this key next to set number of cycle to be run.

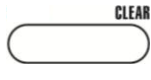
	Action	LCD Display	Description
4.	 <p>Use or</p>		Use JOG or numbering keypad select number of cycle to be run.
5.	 <p>Press</p>		Press this key to start running
6.			Press this key terminate the program running anytime.

Note : whenever to terminate the Preset Program, press “CLEAR” to return to the normal operation.

7. PC connection

The new SDP series can be connect use USB or RS-485. It is auto select between USB and RS-485.

*Please do not connect both USB and RS-485 at the same.

Connect Multiple Power Supplies to PC via RS-485

For multiple power supplies, use the RS-485 Interface through the RS-485 port at rear panel of the power supply. Up to 31 power supplies can be connected via RS-485.

You will need a USB to RS-485 Adapter and the connection shown in Figure 6a & 6b.

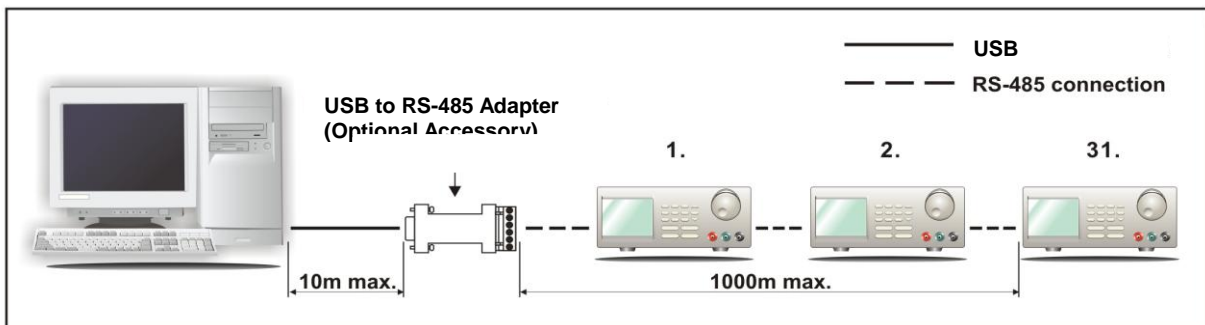

Figure 7a. Connection diagram for multiple power supply

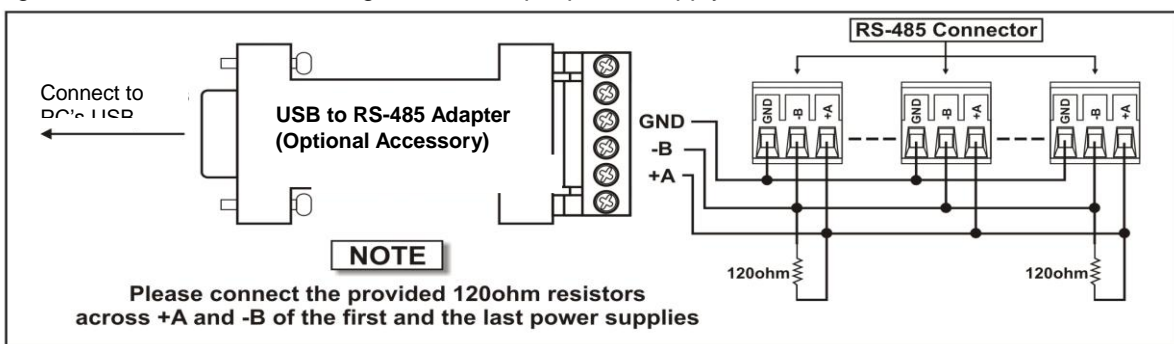

Figure 7b. Connection diagram between USB Adapter and RS-485 Connectors.

APPENDIX A

COMMMAND SET

Remarks in using the Remote Programming Mode The USB/485 interface is always ready for connection to PC for remote programming operation .

{ }- command data, [] - return data, [OK] = "OK", [CR] = 0dh
 ???? = 30h, 30h, 30h, 30h - 39h, 39h, 39h, 39h (4 bytes data)
 ??? = 30h, 30h, 30h - 39h, 39h, 39h (3 bytes data)
 ?? = 30h, 30h - 39h, 39h (2 bytes data)
 <address> 30h, 30h - 3fh, 3fh (2 bytes data).

Bold – Input Command

Italic – Return Data from Power Supply

PS = Power Supply

Command Code & Return Data	Description
Input Command: SESS <address> <CR> Return Data from Power Supply: <i>[OK] [CR]</i>	Disable front panel keypad and make PS to Remote Mode
Input Command: ENDS <address> <CR> Return Data from Power Supply: <i>[OK] [CR]</i>	Enable front panel keypad and make PS to exit Remote Mode
Input Command: CCOM <address> <RS> {000-256} <CR> Return Data from Power Supply: <i>[OK] [CR]</i>	Change RS485 <RS> = 0 -> RS-232 <RS> = 1 -> RS-485
Input Command: GCOM <address> <CR> Return Data from Power Supply: <i>[RS] RS485 Address [??] [CR]</i> <i>[OK] [CR]</i>	Get the RS-485 address
Input Command: GMAX <address> <CR> Return Data from Power Supply: <i>Voltage [???] Current [???] [CR]</i> <i>[OK] [CR]</i>	Get maximum voltage and current of PS
Input Command: GOVP <address> <CR> Return Data from Power Supply: <i>Voltage [???] [CR]</i> <i>[OK] [CR]</i>	Get Upper Voltage Limit of PS
Input Command: GETD <address> <CR>	Get Voltage & Current reading from PS

Command Code & Return Data	Description
Return Data from Power Supply: <i>Voltage [????] Current [????] [0] [CR]</i> <i>[OK] [CR]</i> <i>Voltage [????] Current [????] [1] [CR]</i> <i>[OK] [CR]</i>	PS in CV mode PS in CC mode
Input Command: GETS <address> <CR> Return Data from Power Supply: <i>Voltage [???] Current [???] [CR]</i> <i>[OK] [CR]</i>	Get Voltage & Current Set Value from PS
Input Command: GETM <address> <CR> Return Data from Power Supply: <i>Memory 1 Voltage [???] Current [???] [CR]</i> <i>Memory 2 Voltage [???] Current [???] [CR]</i> <i>Memory 9 Voltage [???] Current [???] [CR]</i> <i>[OK] [CR]</i>	Get All Preset Memory Values from PS
Input Command: GETM <address> location {1-9} <CR> Return Data from Power Supply: <i>Voltage [???] Current [???] [CR]</i> <i>[OK] [CR]</i>	Get Memory from Specific Preset of PS
Input Command: GETP <address> <CR> Return Data from Power Supply: <i>Program 00 Voltage [???] Current [???] Minute [??] Second [??] [CR]</i> <i>Program 01 Voltage [???] Current [???] Minute [??] Second [??] [CR]</i> <i>Program 19 Voltage [???] Current [???] Minute [??] Second [??] [CR]</i> <i>[OK] [CR]</i>	Get all the Timed Program Memory of PS
Input Command: GETP <address> program {00-19} <CR> Return Data from Power Supply: <i>Voltage [???] Current [???] Minute [??] Second [??] [CR]</i> <i>[OK] [CR]</i>	Get Timed Program Memory from Specific Program of PS
Input Command: GPAL <address> [CR] Return Data from Power Supply: <i>Reading voltage [#####] V [ON]</i> <i>Reading current [#####] A [ON]</i>	Get LCD Display Information

Command Code & Return Data	Description
<p>Reading watt [#####] W [ON] Timer minute [#####] second [###] timer [ON] colon [ON] m [ON] s [ON] Setting voltage [###] V-const [ON] V-bar [ON] V [ON] Setting current [###] I-Const [ON] I-bar [ON] A [ON] Program [#] Program [ON] P-bar [ON] SETTING [ON] Key lock [ON] Key open [ON] FAULT [ON] Output on [ON] Output off [ON] Remote [ON] [CR] [OK] [CR]</p>	
<p>Input Command: VOLT <address> voltage {000-XXX} <CR></p> <p>Return Data from Power Supply: [OK] [CR]</p>	<p>Set Voltage Level XXX-Max. Output Rating Voltage = XX.X V Current = X.XX V</p>
<p>Input Command: CURR <address> current {000-XXX} <CR></p> <p>Return Data from Power Supply: [OK] [CR]</p>	<p>Set Current Level</p>
<p>Input Command: SOVP <address> voltage {000-XXX} <CR></p> <p>Return Data from Power Supply: [OK] [CR]</p>	<p>Set Upper Voltage Limit of PS</p>
<p>Input Command: SOUT <address> 1 <CR></p> <p>Return Data from Power Supply: [OK] [CR]</p>	<p>Disable Output of PS</p>
<p>Input Command: SOUT <address> 0 <CR></p> <p>Return Data from Power Supply: [OK] [CR]</p>	<p>Enable Output of PS</p>
<p>Input Command: POWW <address> location {1-9}0 <CR></p> <p>Return Data from Power Supply: [OK] [CR]</p>	<p>Enable the output when switch on the power supply.</p>
<p>Input Command: POWW <address> location {1-9}1 <CR></p> <p>Return Data from Power Supply: [OK] [CR]</p>	<p>Disable the output when switch on the power supply.</p>
<p>Input Command: PROM <address> location {1-9} Voltage {000-XXX} Current {000-XXX} <CR></p> <p>Return Data from Power Supply: [OK] [CR]</p>	<p>Set Voltage and Current values of Preset Memory</p>
<p>Input Command:</p>	

Command Code & Return Data	Description
<p>PROP <address> location {00-19} Voltage {000-XXX} Current {000-XXX} Minute {00-99} Second {00-59} <CR></p> <p>Return Data from Power Supply:</p> <p>[OK] [CR]</p>	<p>Set Voltage, Current and Time period of Timed Program</p>
<p>Input Command:</p> <p>RUNM <address> location {1-9} <CR></p> <p>Return Data from Power Supply:</p> <p>[OK] [CR]</p>	<p>Recall Preset Memory 1-9</p>
<p>Input Command:</p> <p>RUNP <address> times {000-256} <CR></p> <p>Return Data from Power Supply:</p> <p>[OK] [CR]</p>	<p>Run Timed Program (000 = run infinite times)</p>
<p>Input Command:</p> <p>STOP <address> <CR></p> <p>Return Data from Power Supply:</p> <p>[OK] [CR]</p>	<p>Stop Timed Program</p>

This manual is according the latest technical knowing. Technical changings, which are in the interest of progress, reserved.

We herewith confirm that the units are calibrated by the factory according to the specifications as per the technical specifications.

We recommend to calibrate the unit again, after 1 year.

© PeakTech® 04/2021 / AW./EHR.

PeakTech Prüf- und Messtechnik GmbH – Gerstenstieg 4 –
DE-22926 Ahrensburg / Germany



+49-(0) 4102-97398 80



+49-(0) 4102-97398 99



info@peaktech.de



www.peaktech.de